

User Manual

Data Logger

Logger1000A-EU



All Rights Reserved

All Rights Reserved

No part of this document can be reproduced in any form or by any means without the prior written permission of Sungrow Power Supply Co., Ltd (hereinafter "SUNGROW").

Trademark

SUNGROW and other Sungrow trademarks used in this manual are owned by SUNGROW. All other trademarks or registered trademarks mentioned in this manual are owned by their respective owners.

Software Licenses

- It is prohibited to use data contained in firmware or software developed by SUNGROW, in part or in full, for commercial purposes by any means.
- It is prohibited to perform reverse engineering, cracking, or any other operations that compromise the original program design of the software developed by SUNGROW.

About This Manual

The manual mainly contains the product information, as well as guidelines for installation, operation and maintenance. Readers can get additional information at www.sungrowpower.com or on the webpage of the respective component manufacturer.

Validity

This manual is valid for the following models:

- Logger1000A-EU

It is referred to as "Logger1000" hereinafter unless otherwise specified.

Target Group

This manual is intended for qualified technicians who are responsible for installation, operation, and maintenance of the product, and users who need to check inverter parameters.

The product must only be installed by qualified technicians. The qualified technical technician must:

- Have electronic, electrical wiring, and mechanical expertise, and be familiar with electrical and mechanical schematics.
- Have received professional training related to the installation and commissioning of electrical equipment.
- Be able to respond quickly and effectively to dangers or emergencies that may occur during installation and commissioning.
- Be familiar with local standards and relevant safety regulations of electrical systems.
- Read this manual thoroughly and understand the safety instructions related to operations.

How to Use This Manual

Read through this manual carefully before using the product, and keep it properly in an easy-to-reach place.

The information in this manual is subject to ongoing updates and revisions. Although efforts have been made to ensure accuracy, there might be slight variations or errors compared to the actual product. Please refer to the actual product purchased, and the latest manual can be obtained from support.sungrowpower.com or sales channels.

Security Declaration

For details on the product's network security vulnerability response process and vulnerability disclosure, please visit the following website:

<https://en.sungrowpower.com/security-vulnerability-management>

Symbols

This manual contains important safety instructions, which are highlighted with the following symbols, to ensure personal and property safety during usage, or to help optimize the product performance in an efficient way.

Symbols used in this manual are listed below. Please review carefully for better use of this manual.

DANGER

Indicates high-risk potential hazards that, if not avoided, will result in death or serious injury.

WARNING

Indicates moderate-risk potential hazards that, if not avoided, may lead to death or serious injury.

CAUTION

Indicates a slightly hazardous situation which, if not avoided, may result in minor or moderate injury.

NOTICE

Indicates potential risks that, if not avoided, may lead to device malfunction or financial losses.

"NOTE" indicates additional information, important content, or helpful tips that may solve problems or save time.

Contents

- All Rights Reserved..... I
- About This Manual..... II
- 1 Safety Instructions..... 1**
 - 1.1 Understanding Safety Signs..... 1
 - 1.2 General Safety Instructions..... 1
 - 1.3 Packaging, Transportation, and Storage Safety..... 3
 - 1.4 Installation Safety..... 4
 - 1.5 Electrical Connection Safety..... 5
 - 1.6 Operation and Maintenance Safety..... 5
 - 1.7 Disposal Safety..... 6
- 2 Product Overview..... 8**
 - 2.1 Product Description..... 8
 - 2.2 Function Overview..... 9
 - 2.3 Indicators..... 9
 - 2.4 System Structure..... 10
 - 2.4.1 PV System..... 11
 - 2.4.2 Energy Storage System..... 12
 - 2.4.2.1 DC Coupling of C&I ESS..... 12
 - 2.4.2.2 AC Coupling of C&I ESS..... 14
- 3 Unpacking and Storage..... 16**
 - 3.1 Scope of Delivery..... 16
 - 3.2 Unpacking and Inspection..... 17
 - 3.3 Storage Requirements..... 17
- 4 Mechanical Installation..... 18**
 - 4.1 Safety Notes..... 18
 - 4.2 Mounting Requirements..... 18
 - 4.3 Installation Tools..... 20
 - 4.4 Mounting the Data Logger..... 21
 - 4.4.1 Mounting on the Wall..... 21
 - 4.4.2 Mounting on the DIN Rail..... 23
 - 4.5 Installing the Antenna..... 24
 - 4.6 Installing the Power Box..... 25
- 5 Electrical Connection..... 27**
 - 5.1 Safety Notes..... 27

5.2 Port Description.....	27
5.3 Preparing Cables.....	30
5.4 Establishing Inverter Connections.....	31
5.4.1 RS485 Terminal Block Connection.....	31
5.4.2 RJ45 Port Connection.....	32
5.4.3 Connecting to Multiple Inverters.....	33
5.5 Connecting Multiple Data Loggers.....	35
5.6 Connecting to the Energy Meter.....	35
5.6.1 RS485 Port Connection.....	36
5.6.2 Ethernet Connection.....	37
5.7 Connecting to the Meteo Station.....	37
5.7.1 RS485 Port Connection.....	38
5.7.2 AI Port Connection.....	39
5.8 Connecting to the Power Box.....	39
5.9 Connecting to the Backend Monitoring System.....	41
5.10 Installing the Micro-SIM Card.....	42
5.11 Connecting to the Emergency Stop Device.....	42
6 Inspection before Commissioning.....	44
7 Commissioning.....	45
7.1 Establishing a Connection.....	45
7.1.1 Establishing a Connection via Wireless Hotspot.....	45
7.1.2 Establishing a Connection via Ethernet.....	45
7.2 Log in to Web System.....	46
7.2.1 Local Login.....	46
7.2.2 Remote Login via Maintenance Link.....	49
7.3 Overview.....	50
7.3.1 Web UI Overview.....	50
7.3.2 Compatibility.....	51
7.4 Modifying Password.....	51
7.5 Initial Configuration Using the Setup Wizard.....	52
7.6 Selecting Usage Scenario of Web UI.....	54
8 Configuring Data and Network Interfaces.....	55
8.1 RS485 Communication Ports.....	55
8.2 Ethernet.....	55
8.3 Cellular Network.....	56
8.4 WLAN.....	56
8.5 Analog Input (AI) Port.....	57
8.6 Digital Inputs (DI) Port.....	58
8.7 Digital Output (DO) Port.....	59

9 Configuring Data Communication and Transfer Protocols	61
9.1 Setting iSolarCloud Parameters.....	61
9.2 Setting IEC104 Parameters.....	62
9.2.1 IEC104 Forwarding Table.....	62
9.2.2 Setting IEC104 Parameters Using Forwarding Point List.....	64
9.2.3 Setting Communication Interruption Protection.....	64
9.2.4 Restricting IEC104 Communication to Authorized Devices.....	65
9.2.5 Adding a Peer Device.....	65
9.2.6 Configuring SSL Encryption.....	66
9.3 Setting Modbus Parameters.....	66
9.3.1 Setting Communication Interruption Protection.....	67
9.3.2 Restricting Modbus Communication to Authorized Devices.....	67
9.3.3 Adding a Peer Device.....	68
9.3.4 Configuring Serial Port Parameters.....	68
9.3.5 Configuring SSL Encryption.....	68
9.4 Setting Parameters for Third-Party Portal.....	69
9.5 Setting Modbus Parameters.....	70
10 Device Administration	71
10.1 Adding SUNGROW Inverters.....	71
10.2 Adding a Third-Party Device.....	71
10.2.1 Selecting Device.....	71
10.2.2 Importing Device Information by Setting Measuring Points.....	72
10.2.2.1 Verifying Measuring Point Data.....	72
10.2.2.2 Saving Configuration as Template.....	72
10.2.3 Importing Device Information Using a Configuration File.....	72
10.3 Enabling Optimizer/RSD Connection.....	73
10.4 Configuring Device Parameters.....	73
10.4.1 Configuring Parameters for Inverters.....	73
10.4.2 Configuring Parameters for Meter.....	74
10.4.3 Configuring Parameters for Batteries.....	75
10.4.4 Setting Meteo Sensor Parameters.....	75
10.4.5 Correcting Cumulative Power Generation.....	76
10.5 Automatic Frequency Point Assignment.....	76
10.6 Uploading Physical Layout.....	76
10.7 Controlling SUNGROW Inverter.....	77
10.8 Editing Device Information.....	77
10.9 Updating Devices.....	78
10.10 Removing Devices.....	79
10.11 Device Self-Test.....	79
10.12 Enabling Arc Fault Circuit Interrupter (AFCI) Function.....	80

10.13 Configuring Cascaded Scheduling.....	80
11 Device Monitoring.....	82
11.1 Viewing Power Plant and Device Operation Information.....	82
11.2 Viewing Alarms.....	82
12 Exporting Data.....	83
12.1 Exporting Logs of Connected Devices.....	83
12.2 Exporting Logs of Logger1000.....	83
12.3 Exporting Communication Packets.....	83
12.4 Exporting Fault Recorder Data.....	84
13 Power Control (PV System).....	85
13.1 Function Description.....	85
13.2 Interface Description.....	85
13.2.1 Digital Control Interface.....	86
13.2.2 Analog Control Interface.....	87
13.2.3 DRM Control Interface.....	88
13.3 Options for Power Control Method.....	88
13.4 Selecting Power Control Mode.....	89
13.5 Settings for Active Power Control.....	90
13.5.1 Remotely Regulating Active Power.....	90
13.5.1.1 Open-Loop Control.....	90
13.5.1.2 Closed-Loop Control.....	91
13.5.2 Locally Regulating Active Power.....	91
13.5.2.1 Open-Loop Control.....	91
13.5.2.2 Closed-Loop Control.....	92
13.5.2.3 Configuring Adjustment Time and Target Values.....	94
13.5.3 Regulating Active Power via Analog Input.....	95
13.5.4 Regulating Active Power via Digital Input.....	96
13.5.5 Regulating Power via DRM.....	97
13.5.6 Regulating Active Power via Country Mode.....	98
13.5.6.1 Korea.....	98
13.5.6.2 Japan.....	98
13.5.7 Disabling Active Power Control.....	99
13.5.8 Prohibiting the Inverter from Reducing Power Output.....	99
13.6 Settings for Reactive Power Control.....	99
13.6.1 Remotely Regulating Reactive Power.....	99
13.6.2 Locally Regulating Reactive Power.....	100
13.6.3 Regulating Reactive Power via Analog Input.....	101
13.6.4 Regulating Reactive Power via Digital Input.....	102
13.6.5 Regulating Reactive Power via Country Mode.....	103

13.6.6	Disabling Reactive Power Control.....	103
13.6.7	Disabling Reactive Power Output.....	103
13.7	Setting Emergency Stop.....	104
14	Power Control (Energy Storage System).....	105
14.1	Settings for Active Power Control.....	105
14.1.1	Power Regulation using Digital Inputs.....	105
14.1.1.1	Controlling Power via DRM.....	105
14.1.1.2	Controlling Power via Ripple Control.....	105
14.1.1.3	Setting Emergency Stop.....	106
14.1.2	Local Power Control.....	107
14.1.3	Remote Power Control.....	109
14.2	Settings for Reactive Power Control.....	109
15	Energy Management.....	110
15.1	Requirements.....	110
15.1.1	Adding a Meter.....	110
15.1.2	Grid-Connected Power Control.....	111
15.2	Select Energy Management Operating Mode.....	113
15.2.1	Self-Consumption.....	114
15.2.1.1	Demand Control.....	116
15.2.1.2	Adding Battery Usage Plan.....	118
15.2.2	Time Plan.....	122
15.2.2.1	Selecting the Time Plan Mode.....	122
15.2.2.2	Configuring Battery Usage Plan.....	123
15.2.3	Compulsory Mode.....	124
15.2.4	AI Mode.....	124
15.2.5	System Power Backup.....	125
15.3	Set On/Off-Grid Switching.....	125
16	Charger Control.....	128
16.1	Application Scenarios.....	128
16.2	Charger Management.....	130
16.2.1	Adding Chargers.....	130
16.2.2	Configuring Parameters for Chargers.....	130
16.2.3	Viewing Charger Information.....	131
16.2.4	Rebooting Chargers.....	131
16.3	Charger Energy Control.....	132
17	Maintaining the Data Logger.....	134
17.1	Setting System Time.....	134
17.2	Enabling Remote Maintenance.....	134
17.3	Updating the Logger1000.....	135

17.4 Restarting Logger1000.....	135
17.5 Restoring to the Factory Settings.....	136
17.6 Viewing the Firmware Version.....	136
17.7 Viewing History Operations.....	136
17.8 Certificate Management.....	136
17.9 Communication Settings.....	137
17.9.1 Communication Settings in iSolarCloud.....	137
17.9.2 Communication Settings in Third-Party Cloud.....	138
18 User Management.....	139
18.1 User Roles and Permissions.....	139
18.2 Default Accounts and Passwords.....	140
18.3 Setting Up Administrator Account.....	140
18.4 Create User Accounts.....	141
18.5 Delete User Accounts.....	141
18.6 Resetting Account Password.....	142
18.6.1 Reset Account Password.....	142
18.6.2 Resetting Administrator Account Password.....	142
18.7 Setting Account Security Parameters.....	142
18.8 Enabling the O&M Mode.....	143
18.9 Operating System User Accounts.....	143
19 Troubleshooting.....	144
20 FAQ.....	146
20.1 Solution to Insecure HTTPS Connection.....	146
21 Routine Maintenance.....	147
21.1 Safety Notes.....	147
21.2 Maintenance Items.....	147
21.3 Module-Level Rapid Shutdown.....	148
21.4 Replacing Logger1000.....	149
22 Appendix.....	150
22.1 Technical Data.....	150
22.2 Cable Routing Requirements.....	151
22.3 Quality Assurance.....	152
22.4 Contact Information.....	153

1 Safety Instructions



When installing, commissioning, operating, and maintaining the product, strictly observe relevant safety instructions. Improper use or misoperation may result in:

- Injury or death to the operator or a third party.
- Damage to the product or the property of the operator or a third party.

Strictly follow the safety instructions stated in the manual to avoid the hazards mentioned above.

- The safety instructions in this manual are only supplements and cannot cover all the precautions that should be followed. Perform operations considering actual on-site conditions.
- SUNGROW shall not be held liable for any damage caused by violation of general safety operation requirements, general safety standards, or any safety instruction in this manual.
- When installing, operating, and maintaining the device, comply with local laws and regulations. The safety precautions in this manual are only supplements to local laws and regulations.

1.1 Understanding Safety Signs

Symbol	Description
	Read the instructions before performing any operations on the product.
	Do not dispose of the equipment as household waste.

1.2 General Safety Instructions

Regulatory Requirements

- All operations related to the product must comply with relevant laws and regulations of the country or region.
- Obtain permission from the local power department before grid-connected operation.

- Ensure all safety labels on the product remain clear and visible throughout the entire product life cycle. Do not remove, paint over, block or damage any labels or nameplates on the product.
- Ensure that the materials used comply with relevant environmental protection and health and safety standards.
- Take appropriate fire safety measures in accordance with applicable fire safety requirements, such as using flame-retardant materials and installing fire alarm systems.

Personnel Requirements

DANGER

Operators are strictly prohibited from wearing watches, rings, necklaces or other conductive items, which may cause electric shock burns.

WARNING

If any condition or malfunction that may endanger personal safety or damage equipment is found during operations related to the product, stop operations immediately and do not continue using the product.

- Only trained and authorized personnel may operate and maintain the product.
- Operators must understand the correct use of tools and be familiar with all safety precautions mentioned in this manual.
- All operations related to the product must be performed by qualified personnel wearing personal protective equipment.
- All equipment and tools used during product operation and maintenance must be inspected regularly.

Environmental Requirements

DANGER

Do not use or place the product in flammable, explosive or corrosive gas environments.

WARNING

Do not operate the product in severe weather such as thunderstorms, rain, snow, Level 6 or stronger winds, including but not limited to transportation, installation, electrical connection, power-on, maintenance and high-altitude operations.

WARNING

In case of fire, evacuate the building or product area and call the fire department. Do not re-enter the burning area.

NOTICE

Dust and moisture may damage the product!

- **Take appropriate measures such as keeping the product clean and dry if installation or electrical connection needs to be interrupted.**

- Ensure there are no heat sources or flames near the product to prevent overheating or malfunctions.
- Ensure there are no obstructions around the product, maintaining enough ventilation and heat dissipation space.
- Ensure there are no liquids around the product and it is far from areas where liquids may be present to avoid risks of short circuits and electrical faults.
- Avoid using equipment in environments with smoke, dust or other particulate matter.
- Ensure that the product does not interfere with other devices or is affected by interference when operating in an electromagnetic field environment.
- Ensure the working environment temperature and humidity for the product are within specified ranges.

1.3 Packaging, Transportation, and Storage Safety

⚠ CAUTION

Improper handling may cause personal injury!

- **When manually handling the product, the operator must wear personal protective equipment.**
- **When handling the product, consider its weight and keep the balance to prevent it from tilting or falling.**

NOTICE

Improper transportation may cause personal injury or product damage!

- **Select suitable transportation tools based on the product dimensions and weight.**
- **Products should be placed horizontally during transportation, with suitable packaging materials to fix the product in place or prevent impact.**
- **Avoid collisions or severe vibrations during transportation.**

NOTICE

Improper storage may cause product damage!

- **Do not store the product without packaging.**
- **Do not store the product outdoors or in direct sunlight.**

NOTICE

Products stored for over six months should undergo strict protection and necessary inspections. If necessary, install the product only after it has been tested by qualified personnel.

1.4 Installation Safety

⚠ DANGER

Improper installation may cause fire hazards!

- Make sure the product has no electrical connections before installation.
- Prevent foreign objects from entering the interior of the product during installation.

⚠ WARNING

Modification of the product without authorization is strictly prohibited. Unauthorized modifications may lead to serious safety risks, damage product performance, and even cause personal injury.

⚠ CAUTION

When wall drilling is required during installation, ensure that there are no electric cables and water pipes in the wall.

NOTICE

Keep the installation area clean.

- Clean up materials and tools used after product installation.
- Clean empty packaging materials such as cardboard boxes, foam, plastic and zip ties in the operation area.

1.5 Electrical Connection Safety

DANGER

Improper wiring may cause personal injury!

- Comply with the regulations and standards related to the local grid during wiring.
- Electrical connection must be performed by qualified personnel wearing personal protective equipment.
- Before making electrical connections, use a measuring device to ensure the cable is not live. Otherwise, there could be a risk of electric shock!
- Check the power cord and confirm that the identifier is correct before connecting it.
- Use insulated tools during wiring work to prevent short circuits.

1.6 Operation and Maintenance Safety

DANGER

High voltage exists during product operation, and improper operation may endanger personal safety or damage the product!

- Do not touch the enclosure, as there may be risks of electric shock.
- Do not touch energized components, as there may be risks of electric shock.
- Do not touch hot components, as there may be risks of burns.
- Do not dismantle any parts of the product, as there may be risks of electric shock.

DANGER

Damaged product or system failures may cause electric shock or fire!

- Visually inspect the product for damage or other hazards before troubleshooting.
- Ensure all connections are secure.

⚠ DANGER

Improper maintenance may cause personal injury or product damage!

- Before maintenance, switch off all power connections to the product, including internal power supply.
- Ensure the product will not be powered on accidentally.
- Maintenance must be performed by qualified personnel wearing protective equipment and ensuring there are no voltage or current.
- Place prominent warning signs or safety tape around the area to prevent unauthorized access or accidents.
- If there are parts in the operation area that may carry voltage, cover them with insulated cloth for insulation shielding.

⚠ WARNING

Improper maintenance may cause personal injury or product damage!

- Check the warning labels on the enclosure and follow label requirements.
- Confirm that the product, associated external devices, or circuit connections are safe.
- For products that have been powered off for an extended period, a comprehensive inspection must be carried out before powering on, and they can only be put back into use after being checked and tested by qualified personnel.

1.7 Disposal Safety

⚠ CAUTION

Disposed products may contain hazardous substances or potential hazards!

- When disposing of products, comply with local, national, and international regulations and standards.
- During the transportation, storage, and disposal of discarded products, ensure proper measures are taken to prevent the leakage and contamination of hazardous substances, protecting soil, water sources, and air quality.
- Ensure that operators have the necessary training and personal protective equipment, and follow safety procedures. If necessary, entrust a professional team to handle the disposal of products.

NOTICE

Before disposing of products, ensure proper measures are taken to protect data security during the disposal process. This includes using methods such as data erasure, destruction, or encryption to prevent sensitive information from being leaked or misused.

NOTICE

Before disposing of products, ensure safety markings, warning labels, and nameplates are clearly visible.

2 Product Overview

2.1 Product Description

The Logger1000 is a device designed for data collection, power control, and protocol conversion in PV power plants. It combines communication gateway and power plant maintenance functions, providing flexible networking, convenient maintenance, and user-friendly operation.

Unless otherwise noted, illustrations are based on the Logger1000A.

Product Appearance

(1) Front view; (2) Bottom view; (3) Rear view; (4) Side view

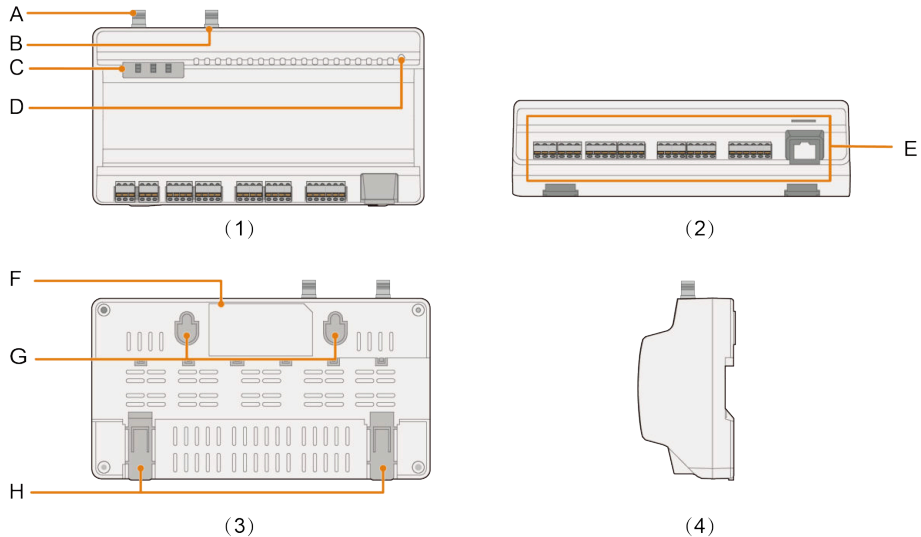

Figure 2-1 Appearance

The images provided in this document are for reference only, and the actual ones may differ.

Item	Name	Description
A	WLAN antenna mounting hole	-
B	4G antenna mounting hole	-
C	Indicators	Indicates the running state of the Logger1000
D	Reset button	Press and hold it for > 3s to restart.

Item	Name	Description
		Press and hold it for > 60s to restore the default settings.
E	Wiring area	See 5.2 Port Description
F	Nameplate	-
G	Wall-mounting holes	Used for wall-mounting
H	Mounting clips	Used for DIN-rail mounting

Dimensions

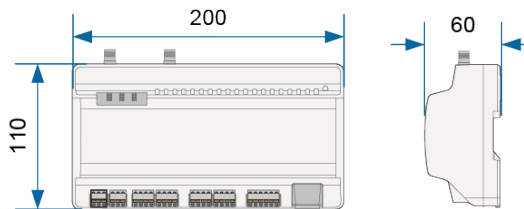

Figure 2-2 Dimensions (unit: mm)

2.2 Function Overview

- **Device Monitoring:** Logger1000's Web UI allows operation and maintenance (O&M) personnel to monitor device status in real-time. They can track the operating conditions of connected devices, identify and address faults promptly.
- **Remote configuration and maintenance:** O&M personnel can access the Web UI remotely to perform routine maintenance task. These include as updating system configuration, modifying device parameters, which helps in reducing maintenance costs.
- **Power control:** The power output of inverters can be controlled through the Web UI. This feature allows O&M personnel to adjust relevant parameters in response to changes in power demand, enhancing the operational reliability of the power station.
- **Energy Management:** With SUNGROW hybrid inverters and batteries connected, O&M personnel can fine-tune the energy usage strategies via the Web UI. This optimization ensures efficient energy utilization and a stable, continuous power supply.

2.3 Indicators

Indicator (print)	LED color	LED status	Description
RUN	Red/green	Off	No external power supply connected

Indicator (print)	LED color	LED status	Description
		Flashing green (every 1 second)	Normal operation
		Flashing red	Faults found in connected inverters
		Steady red	The Logger1000 cannot operating normally
4G*	Blue	Off	No data communication
		Steady on	Connection via 4G is established
		Blinking	Communication connection is being established
WLAN	Blue	Off	No data communication
		Steady on	Connection via WLAN is established
		Blinking	Communication connection is being established

When the 4G or WLAN indicator on the Logger1000 is slowly flashing, it indicates the Logger1000 is establishing a connection to the iSolarCloud. If there is no data communication between the Logger1000 and iSolarCloud for 10 seconds, the indicator will remain steady.

2.4 System Structure

Maximum Number of Connected Devices

The Logger1000 supports connecting a maximum of 30 devices. Devices refer to all components connected via ports and exchanging data with the Logger1000, such as inverters, meteo station, meteo sensor and energy meter in PV power generation systems.

2.4.1 PV System

You can use Logger1000 to monitor the operating status and performance indicators of PV power generation systems, and to collect and record data from inverters and other devices in real time for O&M management and power regulation.

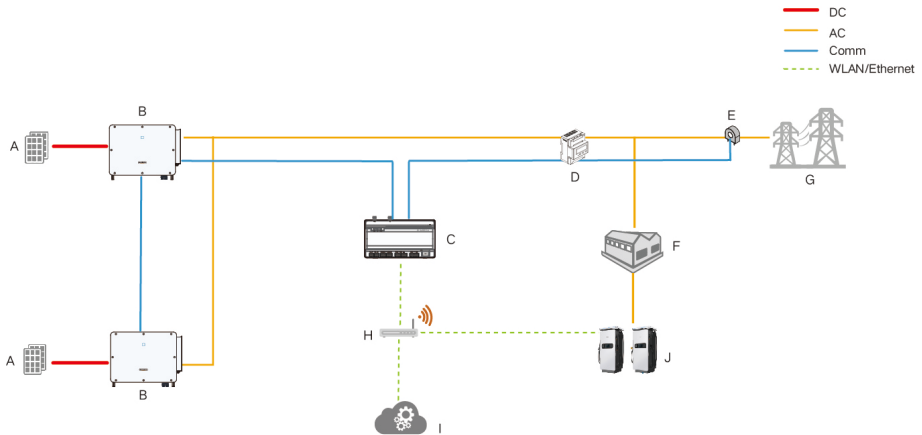

No.	Name	Description
A	PV module	Converts solar energy into DC electricity.
B	PV inverter	Converts the DC power generated by PV modules into AC power.
C	Data logger	Device model: Logger1000. Processes and collects data from various devices in the PV plant, supporting O&M and power regulation.
D	Smart energy meter	Measures energy usage, such as power generation and consumption.
E	Current sensor	Monitors the current in AC cables.
F	Load	Devices or systems that consume energy, such as household appliances or industrial equipment.
G	Grid	-
H	Router	Provides network connectivity to enable data communication between devices and external systems or cloud platforms.
I	iSolarCloud	Used for remote monitoring, management, and analysis of PV plant operation. It offer functions such as real-time data display, alarm notifications, and performance analysis.

No.	Name	Description
J	EV charger	The core output terminal and interface that supplies power to EVs.

2.4.2 Energy Storage System

2.4.2.1 DC Coupling of C&I ESS

When integrated with an ESS comprising batteries and hybrid inverters, the Logger1000 can not only monitor the operational data and performance indicators of the ESS, but also perform comprehensive energy management.

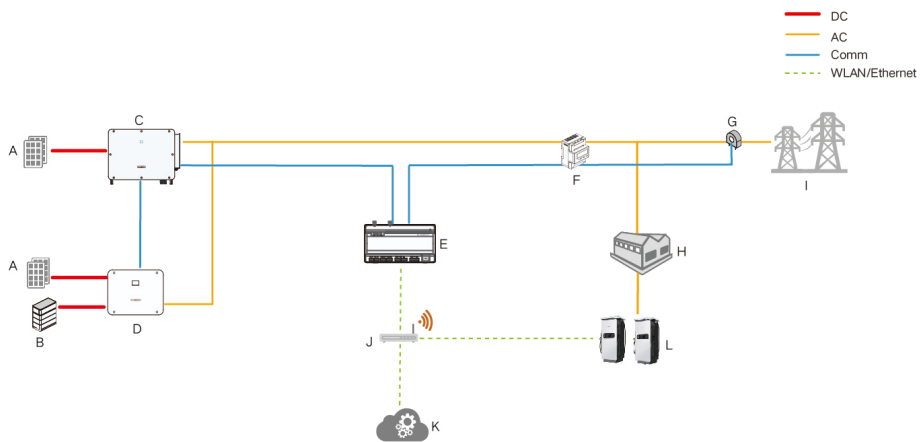
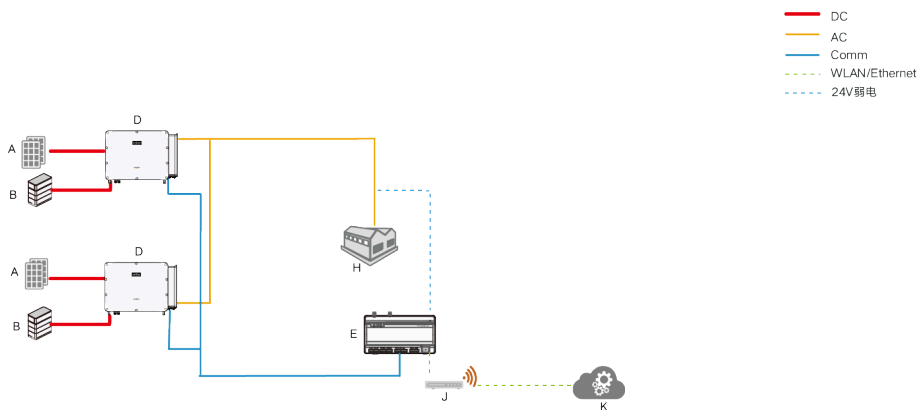

Figure 2-3 On-Grid Scenario



Please connect the AC cable to the inverter's off-grid port.

In off-grid master-slave operation scenarios, only one master device needs to be configured. The system will automatically complete the master-slave configuration and quantity assignment for online hybrid inverters of the same model.

Figure 2-4 Off-Grid Scenario

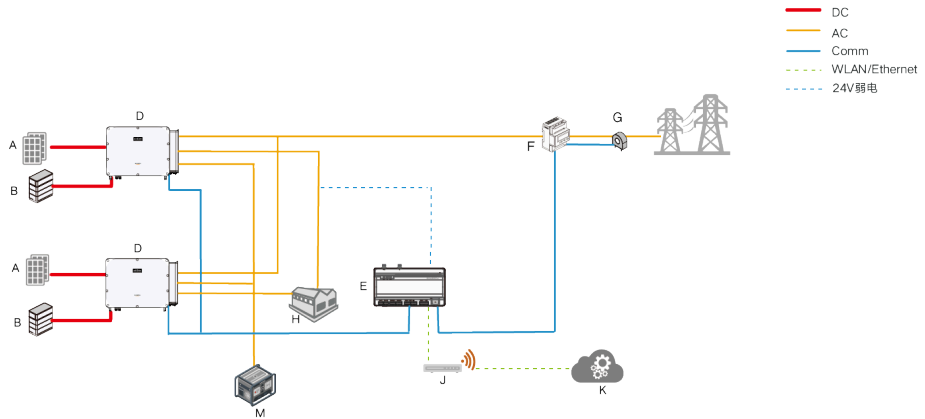

Figure 2-5 On/Off-Grid Switching Scenario

No.	Name	Description
A	PV module	Converts solar energy into DC electricity.
B	Battery	Stores electrical energy and supplies energy to loads.
C	PV inverter	Converts the DC power generated by PV modules into AC power.
D	Hybrid inverter	Converts DC electricity into AC electricity and manages energy storage and release for energy regulation.
E	Data logger	Device model: Logger1000. Processes and collects data from various devices in the PV plant, supporting O&M and power regulation.
F	Smart energy meter	Measures energy usage, such as power generation and consumption.
G	Current sensor	Monitors the current in AC cables.
H	Load	Devices or systems that consume electricity such as household appliances, industrial equipment, etc.
I	Grid	-
J	Router	Provides network connectivity to enable data communication between devices and external systems or cloud platforms.
K	iSolarCloud	Used for remote monitoring, management, and analysis of PV plant operation. It offers functions such as real-

No.	Name	Description
		time data display, alarm notifications, and performance analysis.
L	Charger	The core output terminal and interface that supplies power to EVs. <div style="border: 1px solid gray; padding: 5px; margin-top: 10px;">Only certain hybrid inverter models support connection of chargers.</div>
M	Diesel generator	Starts when the grid is offline and battery SOC is low, providing backup power for the load.

2.4.2.2 AC Coupling of C&I ESS

When integrated with an ESS, the Logger1000 can not only monitor operational data and performance indicators of the system, but also perform power regulation and energy management for the ESS.

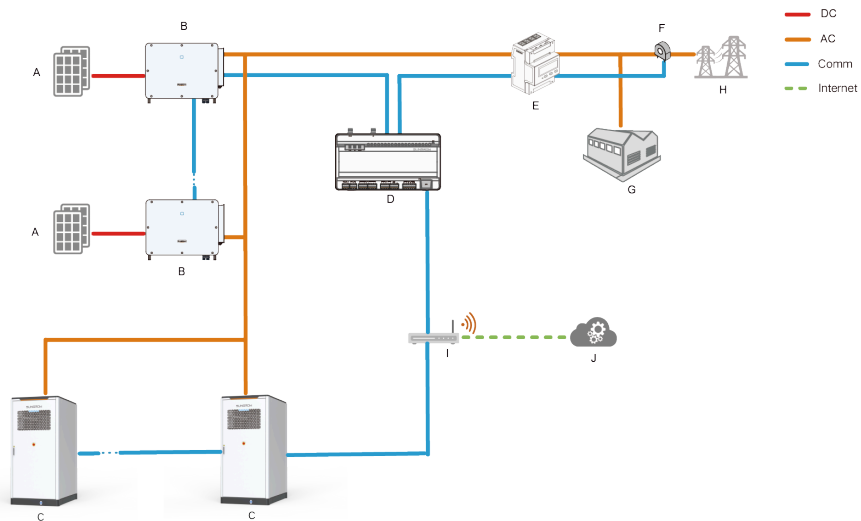

No.	Name	Description
A	PV module	Converts solar energy into DC electricity.
B	PV inverter	Converts the DC power generated by PV modules into AC power.
C	ESS	Used to store energy and release it when needed to supply power to loads.
D	Data Logger	Device model: Logger1000.

No.	Name	Description
		Processes and collects data from various devices in the PV plant, supporting O&M and power regulation.
E	Smart energy meter	Measures energy usage, such as power generation and consumption.
F	Current sensor	Monitors the current in AC cables.
G	Load	Devices or systems that consume energy, such as household appliances or industrial equipment.
H	Grid	-
I	Router	Provides network connectivity to enable data communication between devices and external systems or cloud platforms.
J	iSolarCloud	Used for remote monitoring, management, and analysis of PV plant operation. It offer functions such as real-time data display, alarm notifications, and performance analysis.

3 Unpacking and Storage

3.1 Scope of Delivery

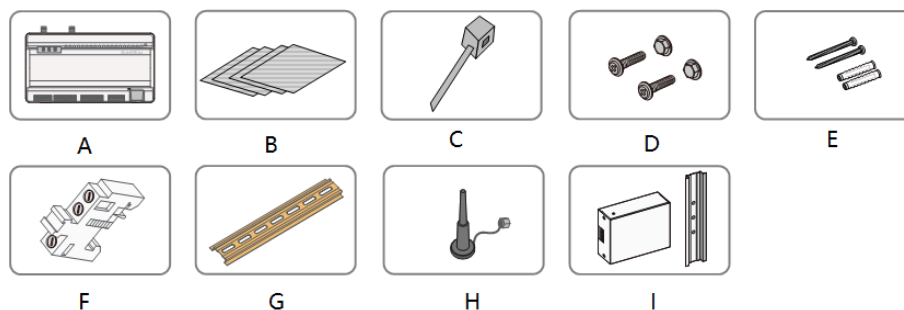

Figure 3-1 Scope of delivery

Item	Name	Description
A	Data Logger	Logger1000
B	Documents	Quick Installation Guide, quality certificate, packing list, product test report, and warranty card
C	Nylon cable tie	Used to tie cables
D	Fastener assembly	4 sets, M4x16, used for wall-mounting to secure the Logger1000 on the metal surface
E	Expansion bolt	4 sets, ST4.8x19, used for wall-mounting to secure the Logger1000 on the concrete wall
F	DIN rail end brackets	2 sets, E/UK-1201442, used to secure the Logger1000 on the DIN rail
G	DIN rail (top-hat rail)	Length: 240mm
H	WLAN antenna/4G antenna	-
I	Power box	Converts the AC current into DC current. Length of the provided DIN rail: 170mm

3.2 Unpacking and Inspection

The product is thoroughly inspected and packed before delivery. However, it is possible for damage to occur during transport. Check the following items carefully once receiving the product.

- Check if the packing list matches the items included in the delivery.
- Check the product thoroughly and ensure there are no visible damages.
- Confirm that the received model is the same as the purchased one.
- Verify that all safety signs, warning labels, and the nameplate on the product are clear and legible.

If any damage is found, do not proceed with the installation, and contact the forwarding company or SUNGROW. Please provide photos of the damaged areas to facilitate the service process.

3.3 Storage Requirements

If the product is not immediately installed or operated on-site after completing delivery acceptance, store it properly.

If the product will not be installed immediately, store it in its original packaging.

NOTICE

Losses caused by storage not in accordance with this manual are not covered by the warranty.

- If stacking packaged products, stack no more than 8 layers vertically and take additional protective measures.
- Store the product in a ventilated, dry, and clean indoor environment with its packaging.
- Ensure that the storage carrier can support the weight of the packaged product.
- Ensure the device is kept in a well-ventilated and moisture-proof place, without accumulation of water.
- Ambient temperature: $-40^{\circ}\text{C}\sim+70^{\circ}\text{C}$. Relative humidity: 0~95%, no condensation.
- Consider the surrounding harsh environment like sudden temperature changes or collision to avoid product damage.
- Carry out inspections periodically. Check whether the packaging is intact and prevent any damage that may be caused by pests and animals. Replace the packaging immediately if it is damaged.
- Conduct regular inspection, preferably at least once a week. Check the packaging for signs of damages and prevent insects and or rodents. Replace the packaging immediately if it is damaged.

4 Mechanical Installation

4.1 Safety Notes

⚠ WARNING

Improper installation may cause personal injury or product damage!

- Further operations can only be performed after professional evaluation by SUNGROW that the installation environment meets requirements.
- Only intact and undamaged products can be installed.
- Tighten the product or related equipment to the specified torque to avoid affecting product performance and lifespan.

NOTICE

Losses resulting from installation not in accordance with this manual are not covered by the warranty.

4.2 Mounting Requirements

Select the best installation location for the Logger1000 is important for ensuring its safe operation, prolonging its lifespan, and maintaining performance.

Environment Requirements

NOTICE

High humidity in the installation environment may cause internal component damage to the Logger1000.

NOTICE

When connecting outdoor equipment, such as a Meteo Station, to the Logger1000, install a Surge Protection Device (SPD) to protect the communication system. Select the proper SPD based on the site conditions and requirements.

- The mounting location must be indoors.
- No inclination installation is allowed.
- Temperature and humidity must meet the following requirements.

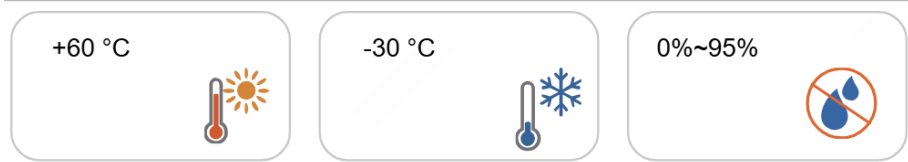

- Protect the product from moisture and chemically corrosive substances.
- When installed horizontally, ensure the installation position allows for easy visibility of indicators.

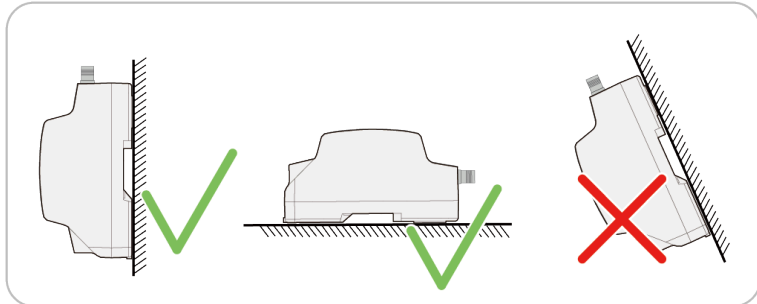

Clearance Requirements

Ensure that the installation space for the product meets the requirements for of heat dissipation, maintenance, while reserving an appropriate distance based on the surrounding conditions.

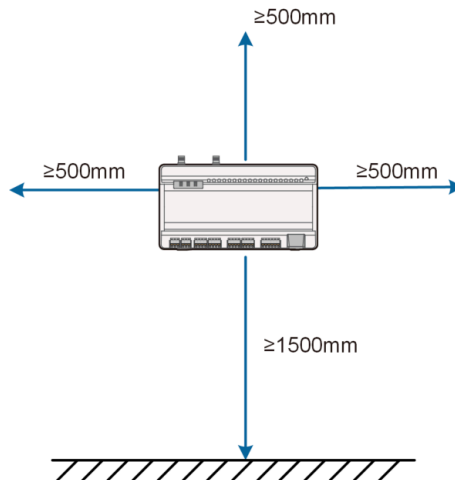

Figure 4-1 Minimum spacing

When determining the installation location, ensure the power cable from the power box can reach and connect to the power input port of the Logger1000.

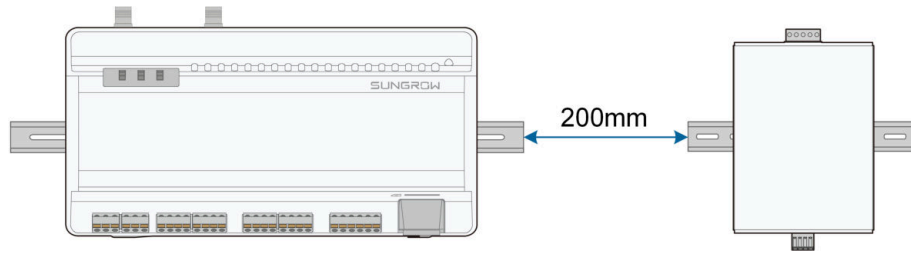
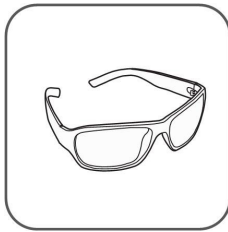

Figure 4-2 Spacing with the power box

4.3 Installation Tools

Installation tools are not included in the supply scope and must be prepared by the installer.

Installation tools include, but are not limited to, the following recommended ones. If necessary, use other auxiliary tools on site.



Protective
eyewear

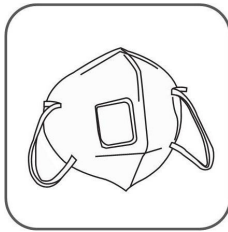

Dust mask



Insulated gloves

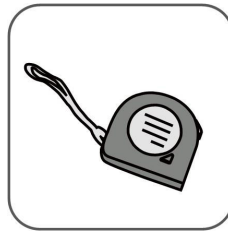

Measuring tape

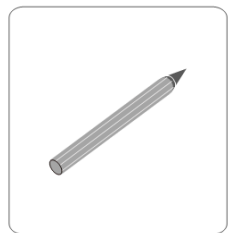

Marker

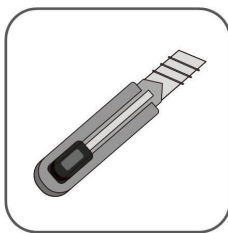

Utility knife



Electric
screwdriver



Phillips
screwdriver



Hammer drill

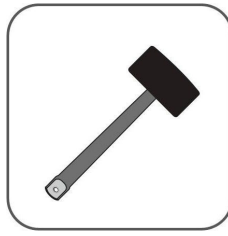

Rubber mallet

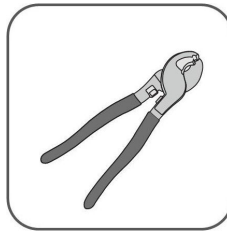

Wire cutter



Wire stripper



Hot air gun



Vacuum cleaner

4.4 Mounting the Data Logger

The Logger1000 can be mounted on the wall, or on the DIN rail.

4.4.1 Mounting on the Wall

Secure the Logger1000 through the wall-mounting holes.

Prerequisite

⚠ WARNING

Make sure to avoid water pipes and electricity wiring in the wall before drilling.

- The wall surface is smooth and secure.
- Operation personnel have worn protective eyewear and dust mask to prevent dust from entering eyes or being inhaled.

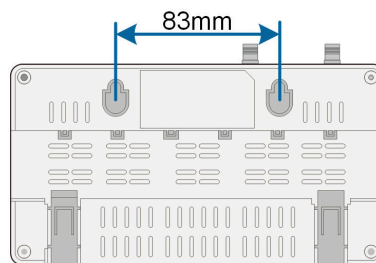
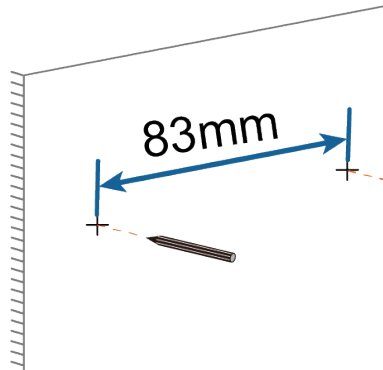
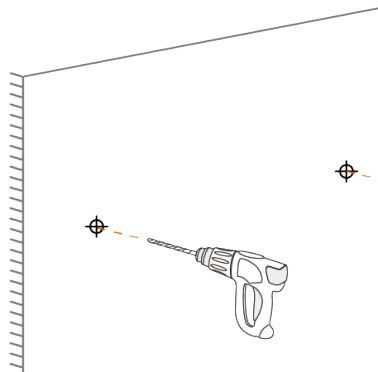

Figure 4-3 Wall-mounting hole dimensions

Step 1 Mark positions for drilling holes with a marker.



Step 2 Drill the holes with a drill at the marked positions.



Step 3 For installation on a concrete wall, insert expansion bolts into the drilled holes, and tighten them so that approximately 5mm of the bolt protrudes from the wall surface.

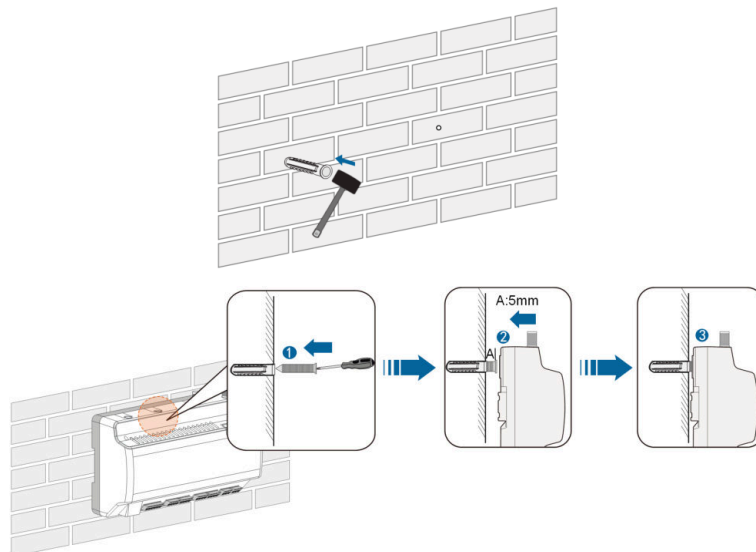

Step 4 For installation on a metal wall, secure the Logger1000 using bolts and nuts, ensuring that the bolts extend approximately 5mm beyond the wall surface.

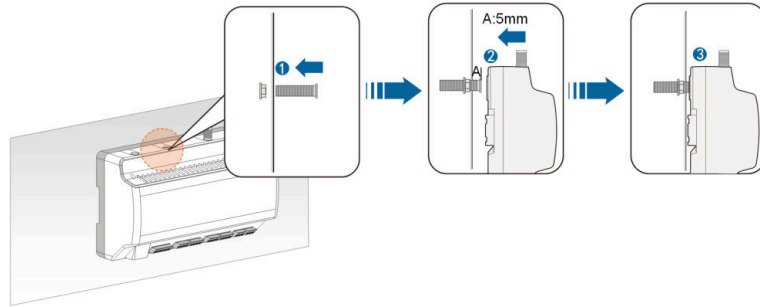

Step 5 Align the mounting holes of the Logger1000 with the protruding bolts.

Step 6 Double-check the Logger1000 to make sure it is firmly installed.

--End

4.4.2 Mounting on the DIN Rail

Secure the Logger1000 in place on the DIN rail using the mounting clips.

Prerequisite

- The DIN rail is installed at the desired location, and is securely fastened.

Step 1 Use a flat-head screwdriver or a similar tool to gently press down on the recessed part of the Logger1000's mounting clips, then pull the clips outward to prepare for attachment.

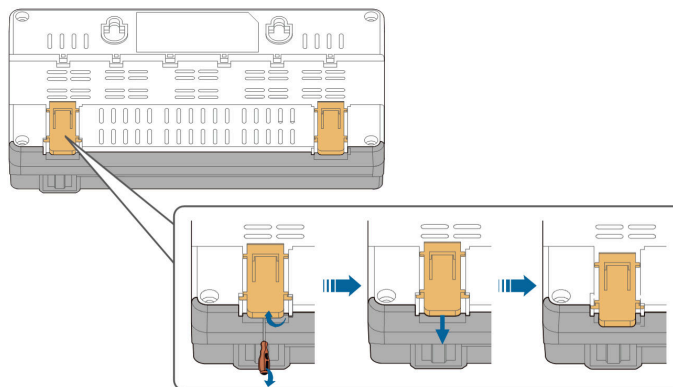

Step 2 Hold the Logger1000 parallel to the DIN rail and align the central mounting hook with the rail.

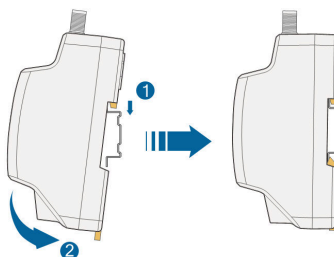

Step 3 Push the mounting clips upwards to its original position to lock the Logger1000 onto the DIN rail.

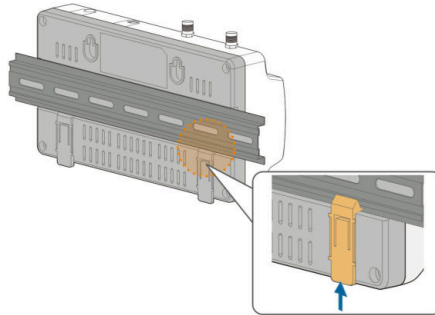

Step 4 Tighten the end brackets at both ends of the DIN rail to prevent any lateral movement of the Logger1000.

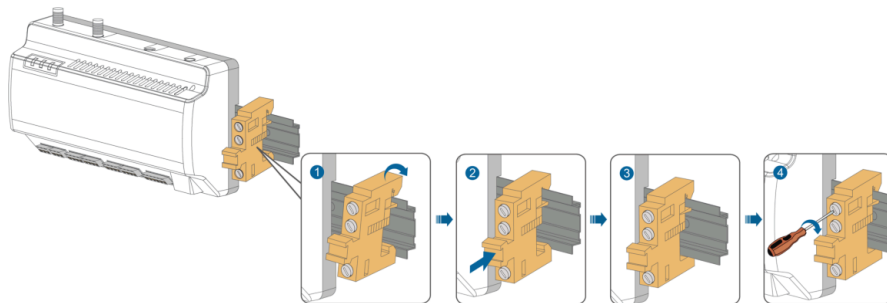

Step 5 Double-check the Logger1000 to make sure it is firmly installed.

--End

4.5 Installing the Antenna

Prerequisite

NOTICE

For optimal signal reception, ensure the antenna with its suction cup base is positioned outside of any metal enclosures or metal walls. Metal surfaces can significantly interfere with signal strength.

- The suction cup base has already been fixed outside the metal enclosure or metal wall.
- An antenna outlet has been reserved (diameter: 20mm).

Step 1 Lead the threaded end of antenna cable towards the Logger1000.

Step 2 Align the threaded end of the antenna cable with the designated 4G or WLAN antenna mounting hole on the Logger1000, and hand-tighten the attached nut in a clockwise direction until it is secure.

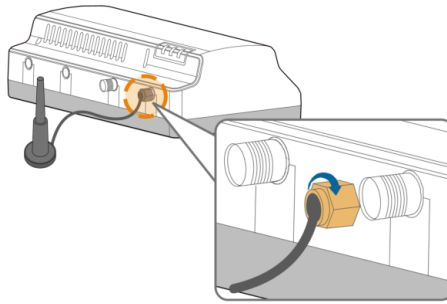

--End

4.6 Installing the Power Box

Secure the power box in place on the DIN rail using the mounting clips.

Prerequisite

- The DIN rail is installed at the desired location, and is securely fastened.
- The power box is positioned at an appropriate distance from the Logger1000, and the power cable can be connected to the power input port of the Logger1000.

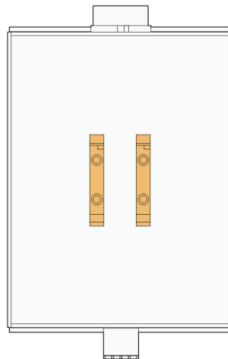
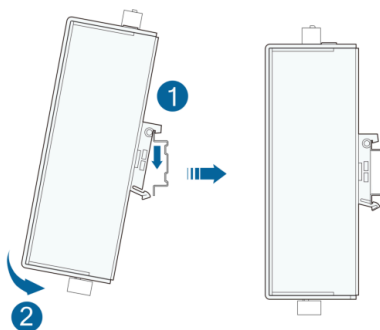

Figure 4-4 Mounting hook of the power box

Step 1 Hold the power box parallel to the DIN rail and align the central mounting hook with the rail.

Step 2 Press down the power box until it snaps into place with an audible "Click" sound.



Step 3 Double-check the power box to make sure it is firmly installed.

--End

5 Electrical Connection

5.1 Safety Notes

⚠ WARNING

Improper wiring may cause personal injury or product damage!

- Only complete and undamaged products can be proceeded with electrical connection.
- Fasten terminals with the specified torque to prevent electrical faults.

NOTICE

Improper wiring may cause product damage!

- Cables used must meet specifications, have secure connections and is well-insulated.
- Do not pull cables or wires forcefully during electrical connections to avoid damaging their insulation.
- Ensure sufficient bending space for all cables and wires.
- Take necessary auxiliary measures to reduce the stress on cables or wires.
- Keep cables at a sufficient distance from heat-generating components to prevent insulation deterioration or damage due to high temperatures.

NOTICE

Losses caused by electrical connection not in accordance with this manual are not covered by the warranty.

5.2 Port Description

The external wiring area can be found at the bottom of Logger1000.

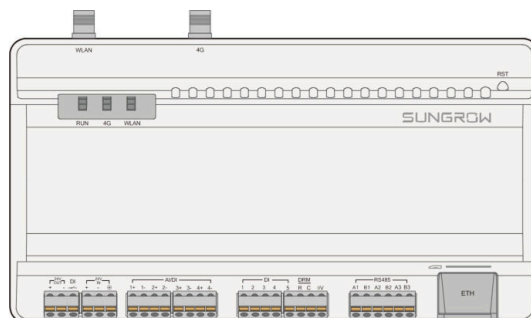



Table 5-1 External Port Description

Port (Screen Printing)	Function	
24V OUT	24V power output	24V+5%, with a maximum output current of 0.5 A
DI	Switch from AI to DI	Enabling the switch from AI to DI
24V IN	24V power input	24V+3%
	Grounding	Used to connect a protective grounding cable
AI/DI	Compatible with AI and DI	By default, AI input deploys 0–10V or 4–20 mA
DI	Digital input	Dry contact signal input
DRM	Demand Response Modes	Achieving the DRM function along with DI1–DI4
0V	Digital input reference	-
RS485	RS485 communication interface	Supporting 3-port RS485 wiring
 *	SIM card slot	Supporting micro-SIM cards
ETH	Ethernet port	Can be connected to the backend management system via devices such as a router or switch
WLAN	WLAN antenna	-
4G*	4G antenna	-
RST	Reset port	Press and hold (>30s) to restart the data logger and restore factory settings Short press (<3s). This function is reserved.

The maximum communication distance of RS485 (A1B1–A3B3) ports is 1000 m.

Table 5-2 Port Matrix

Port No.	Description
21	Used to connect to third-party devices via File Transfer Protocol (FTP). This port is disabled by default and is enabled only when required by the connected third-party device.
22	Used to connect to the server via Secure File Transfer Protocol (SFTP) for transferring data such as log files.
53	Used to resolve the domain name to its corresponding IP address via Domain Name System (DNS). The port is enabled by default.
67	Used to obtain IP addresses via Dynamic Host Configuration Protocol (DHCP). The port is enabled by default.
443	Connect to Logger1000 via the Hypertext Transfer Protocol Secure (HTTPS) protocol.
502	Used to connect SUNGROW devices or third-party management systems to Logger1000 via Modbus TCP. The port is disabled by default, and Secure Sockets Layer (SSL) encryption is inactive.
516	Used to connect SUNGROW devices or third-party management systems to Logger1000 via Modbus TCP. The port is enabled by default, and SSL encryption is applied.
2404	Used to connect SUNGROW devices or third-party management systems to Logger1000 via IEC 104. The port is disabled by default, and SSL encryption is inactive.
2418	Used to connect SUNGROW devices or third-party management systems to Logger1000 via IEC 104. The port is

Port No.	Description
	enabled by default, and SSL encryption is applied.
5353	Used for fast network configuration via Multicast DNS (mDNS). The port is enabled by default.
49152–65535	Used for the HTTP server to dynamically apply for a port for internal message communication.

5.3 Preparing Cables

Cable	Specification	Remarks
RS485 cable	Two-core or multi-core cables with a cross-sectional area of 0.75 mm ² . The recommended maximum wiring distance is less than 1000 m.	Shielded twisted-pair cable
RJ45 Ethernet cable	Cat5e or above network cables. The recommended maximum communication distance is less than 100 m.	-
Signal cables for AI, DI, and DO	Two-core or multi-core cables with a cross-sectional area of 0.65 mm ² or 0.75 mm ² , or a gauge of 19 AWG. The recommended maximum wiring distance is 10 m.	-
Power cable	Two-core or multi-core cables with a cross-sectional area of 0.65 mm ² or a gauge of 19 AWG.	-
DC cable, AC cable	Two-core or multi-core cables with a cross-	-

Cable	Specification	Remarks
	sectional area of 0.65 mm ² or a gauge of 19 AWG.	
Grounding cable	Cables with a cross-sectional area of 0.75 mm ² .	-

5.4 Establishing Inverter Connections

Establish a connection between the Logger1000 and the inverter.

For SUNGROW inverters, establish a connection with the Logger1000 using either the inverter's RS485 terminal block or RJ45 port, depending on the actual setup and requirements.

5.4.1 RS485 Terminal Block Connection

Prerequisite

- An RS485 communication cable that meets the specifications is available. See [5.3 Preparing Cables](#).

⚠ DANGER

Accidental contact with live terminals may cause fatal electric shock!

- Ensure the product is powered off before wiring.
- Ensure terminals are not live before wiring.

NOTICE

The RS485 communication cable must be a shielded twisted pair with single-point grounding of the shielding.

Step 1 Lead the RS485 cable from the inverter to the wiring area of the Logger1000.

Step 2 Strip 15 mm of the sheath from the product end of the RS485 cable, and strip 8~10 mm of the insulation using a wire stripper.

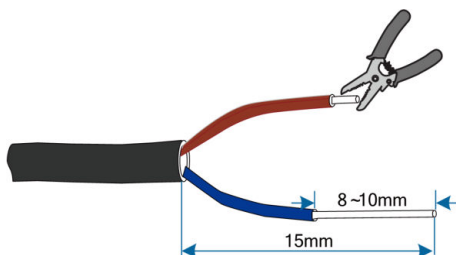

Step 3 Crimp and connect the stripped wires to the proper terminal block, and plug the terminal block to the RS485 port of the Logger1000.

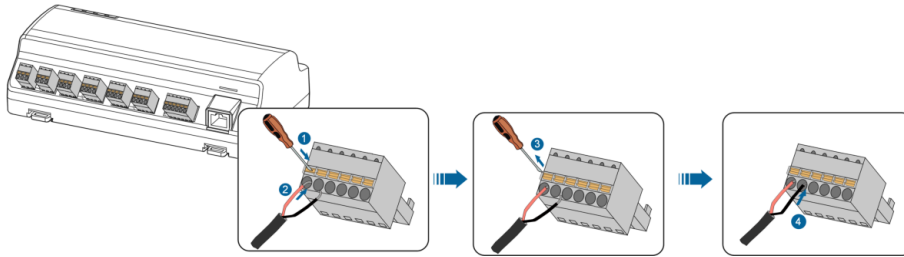

NOTICE

Connect RS485A to port A and RS485B to port B.

Step 4 Connect the other end of the RS485 cable to the RS485 port of the inverter.

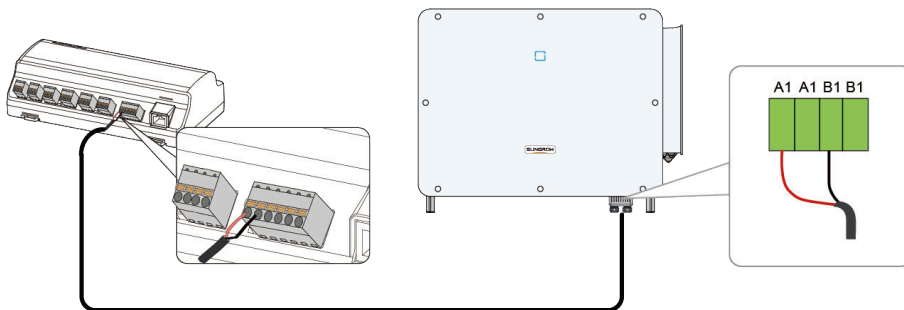

--End

5.4.2 RJ45 Port Connection

Prerequisite

- An RJ45 communication cable that meets the specifications is available. See [5.3 Preparing Cables](#).

⚠ DANGER

Accidental contact with live terminals may cause fatal electric shock!

- **Ensure the product is powered off before wiring.**
- **Ensure terminals are not live before wiring.**

Step 1 Lead the RJ45 communication cable from the inverter to the wiring area of the Logger1000.

Step 2 Prepare the communication cable.

- Strip the insulation of the RJ45 cable with an Ethernet wire stripper. Gently separate and pull out the wires connected to pin 3 (green/white) and pin 6 (green).

The wires from pin 3 and pin 4 are used for communication connection.

The wire from pin 3 should be connected to the terminal designated for RS485- B, and the wire from pin 6 to the terminal designated for RS485+ A.

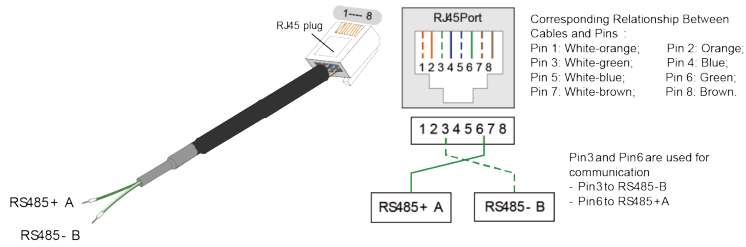

- b. Put bootlace ferrule onto the wires and crimp them using a crimping tool.
- c. Trim unused wires and slide a piece of heat-shrink tubing over the end of the RJ45 cable.
- d. Heat the tubing using a heat gun, until it fits tightly around the cable.

Step 3 Connect the stripped wires to the terminal block, and plug the terminal block to the RS485 port of the Logger1000.

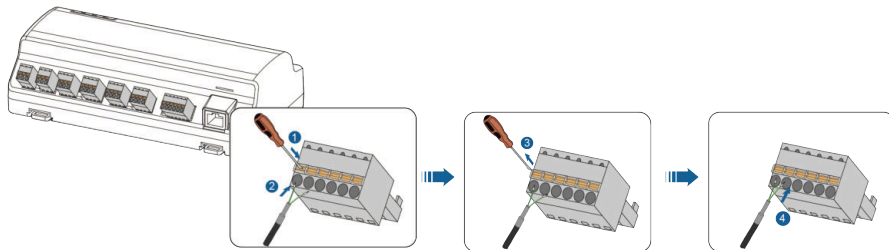

Step 4 Insert the RJ45 plug into the inverter and ensure it snaps into place.

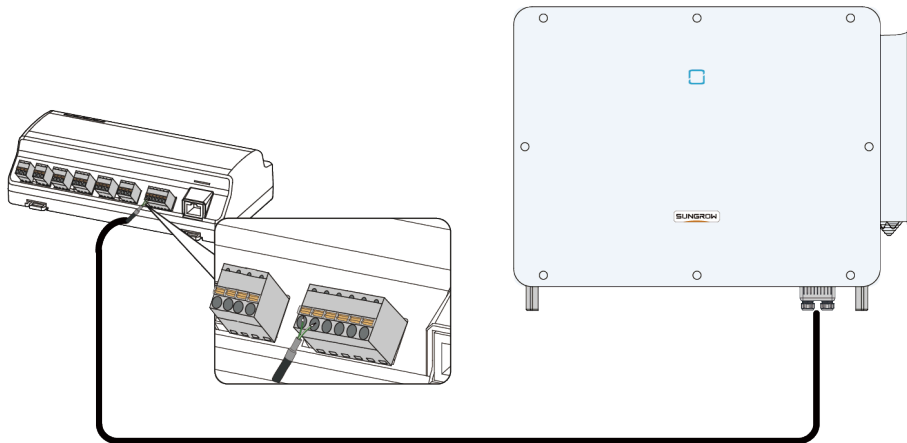

--End

5.4.3 Connecting to Multiple Inverters

Establish connections between the Logger1000 and multiple inverters to enable comprehensive monitoring and management of connected devices. When communicating with multiple inverters, the inverters are connected to each other in a daisy chain manner using RS485 communication cables.

⚠ DANGER

Accidental contact with live terminals may cause fatal electric shock!

- Ensure the product is powered off before wiring.
- Ensure terminals are not live before wiring.

NOTICE

When connecting outdoor devices, it is recommended to add lightning protection devices, otherwise the Logger1000 may be damaged by a lightning strike.

Wiring Instructions

- When the number of device types is less than or equal to the number of RS485 ports of the Logger1000, it is recommended to connect different types of devices to different RS485 ports.
- On each RS485 bus, the baud rate, data bits, stop bits, and parity bits of all devices must be consistent with the RS485 communication parameters of the Logger1000's COM port.
- The address of each device on the RS485 bus must be within the address range set by the Logger1000, and there must be no duplicates, otherwise communication will fail.
 - Address range for SUNGROW inverters: 1~247
 - Address range for third-party inverters: 1~255

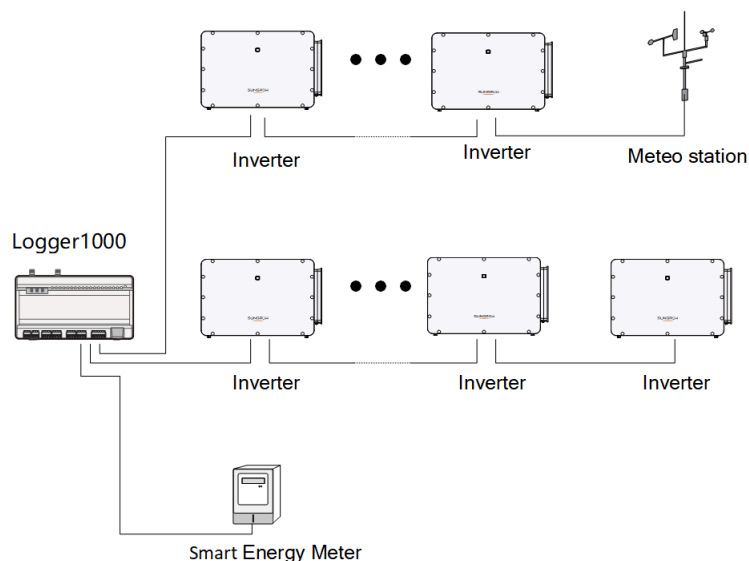

Figure 5-1 Logger1000 connecting to multiple inverters

5.5 Connecting Multiple Data Loggers

Connecting multiple Logger1000 devices to a core switch or 4G router enables data transmission to the backend or the iSolarCloud, thereby facilitating centralized data management and monitoring.

⚠ DANGER

Accidental contact with live terminals may cause fatal electric shock!

- **Ensure the product is powered off before wiring.**
- **Ensure terminals are not live before wiring.**

Step 1 Connect multiple Logger1000 devices to the same core switch or router.

Step 2 Perform basic configuration for each Logger1000.

--End

5.6 Connecting to the Energy Meter

Connect the Logger1000 to an energy meter to read meter data in real time for recording and analysis.

Logger1000 can be connected to the Smart Energy Meter through RS485 port or Ethernet port.

It is recommended to use a meter that complies with the DL/T645-1997/2007 protocol or Modbus protocol requirements.

The DTSD1352 meter must be purchased through the channels designated by Sungrow.

- For scenarios with a high demand for zero export (for example, the response time of zero export detection is 500 ms), it is recommended to use DTS666-20, DRPR-72, or similar meters with the refresh time less than 50 ms, and ensure that the inverter supports ultra-fast dispatch and that the ultra-fast grid dispatch mode is enabled for Logger1000.
- For scenarios with a lenient performance demand (for example, the response time of zero export detection is 2 s), it is recommended to use EM610, DTSD1352, UMG604/UMG104, or similar meters with the refresh time less than 200 ms, and ensure that the inverter supports ultra-fast dispatch and that the ultra-fast grid dispatch mode is enabled for Logger1000.

Table 5-3 Recommended models of energy meter

Manufacturer	Model	Protocol Type	Wiring
Sfere	PD194E/Z		
Acrel	PZ96-E3		
	DTSD1352		
Weidmueller	EM 610	Modbus RTU	5.6.1 RS485 Port Connection
SUNGROW	DTSU666		
	DTSU666-20		
Schneider	IEM3255		
Janitza	UMG604/	• Modbus RTU	• 5.6.1 RS485 Port Connection
	UMG104	• Modbus TCP	• 5.6.2 Ethernet Connection

5.6.1 RS485 Port Connection

Prerequisite

- All devices on each RS485 bus need to be configured with the same serial port parameters.

⚠ DANGER

Accidental contact with live terminals may cause fatal electric shock!

- **Ensure the product is powered off before wiring.**
- **Ensure terminals are not live before wiring.**

When using Weidmüller or Janitza meters, connect the RS485 A/B port of the meter to the RS485 B/A port of the Logger1000.

- Connect the RS485 cable led from the Smart Energy Meter to the RS485 port of the Logger1000.

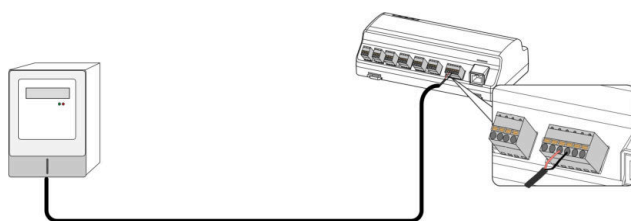

5.6.2 Ethernet Connection

Prerequisite

- Two appropriately sized network cables have been prepared.
- An Ethernet switch is available.

⚠ DANGER

Accidental contact with live terminals may cause fatal electric shock!

- **Ensure the product is powered off before wiring.**
- **Ensure terminals are not live before wiring.**

For optimal transmission effects, it is recommended to use shielded cables of CAT5E or higher. Ensure that the actual usage distance does not exceed 90 meters.

Step 1 Insert the RJ45 plug of the Ethernet cable led from the Smart Energy Meter to the Ethernet switch.

Step 2 Connect one end of the other Ethernet cable to the Ethernet switch, and the other end to the "ETH" port of the Logger1000.

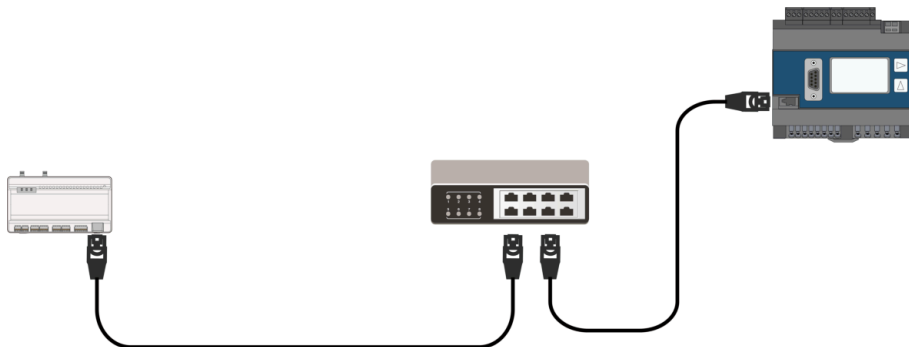

Step 3 If a switch is not used, directly connect the cable from the meter to the "ETH" port of the Logger1000.

--End

5.7 Connecting to the Meteo Station

Connect the Logger1000 to environmental monitoring equipment to obtain and monitor environmental data such as temperature and humidity.

Meteo Station can be connected to Logger1000 through RS485 port or AI port.

It is recommended to use Meteo Station that complies with the Modbus protocol.

Table 5-4 Recommended models of Meteo Station

Model	Wiring
PC-4	
PC-4 PRO	
WING-TRACKER	
WS601	
SMP10	5.7.1 RS485 Port Connection
RT1	
PVMet75	
PVMet200	
Si-RS485TC	
TEMPER_SENSOR	5.7.2 AI Port Connection
Meteo sensor	

5.7.1 RS485 Port Connection

⚠ DANGER

Accidental contact with live terminals may cause fatal electric shock!

- Ensure the product is powered off before wiring.
- Ensure terminals are not live before wiring.

- Connect RS485 cable led from the Meteo Station to the RS485 port of the Logger1000.

If multiple inverters and Meteo Station are connected to the Logger1000 at the same time, the Meteo Station should be connected to the end of the daisy chain.

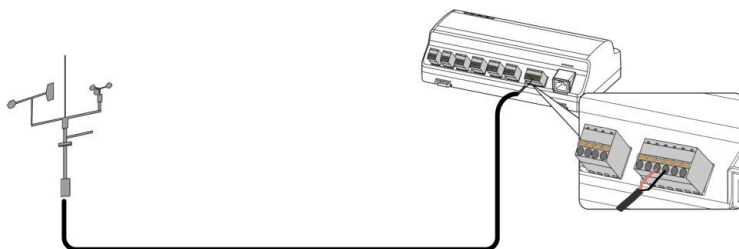

5.7.2 AI Port Connection

⚠ DANGER

Accidental contact with live terminals may cause fatal electric shock!

- Ensure the product is powered off before wiring.
- Ensure terminals are not live before wiring.

- Connect the communication cable led from the meteo sensor to the AI port of the Logger1000.

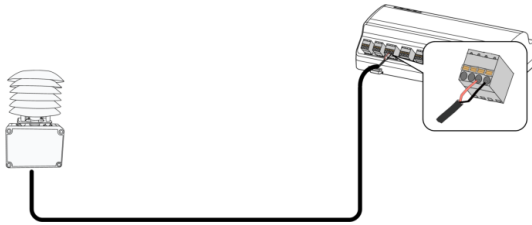

5.8 Connecting to the Power Box

Prerequisite

- Two-core DC cable, three-core AC cable, and grounding cable that meet the specifications have been prepared. See [5.3 Preparing Cables](#).

⚠ DANGER

Accidental contact with live terminals may cause fatal electric shock!

- Ensure the product is powered off before wiring.
- Ensure terminals are not live before wiring.

- Step 1** Strip 15 mm of the sheath from both the DC and AC cables, and strip 8~10 mm of the insulation using a wire stripper.

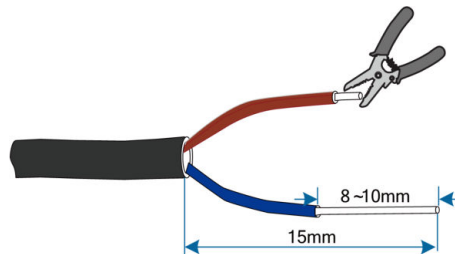

Figure 5-2 DC cable

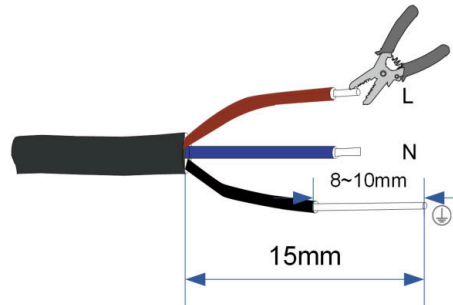
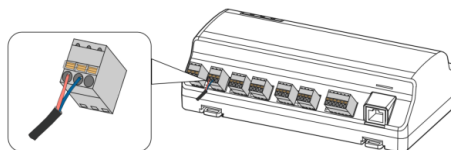

Figure 5-3 AC cable

Step 2 Strip 8~10 mm of the sheath from the grounding cable using a wire stripper.



Step 3 Connect the stripped DC cable wires to the terminal block, and plug the terminal block into the "24V IN" port of the Logger1000.



If other devices require 24V DC power, use a DC cable to connect the "24V OUT" port of the Logger1000 to the "24V IN" port of that device, following the steps mentioned above.

Step 4 Connect the stripped grounding cable to the corresponding port of the Logger1000.

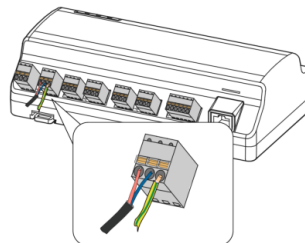

Step 5 Connect the DC cable led from the "24V IN" port of the Logger1000 to the "DC 24V OUT" port of the power box.

Step 6 Connect the stripped AC cable wires to the "AC (100~277V)" port of the power box, and connect the other end of the AC cable to the 220V AC power.

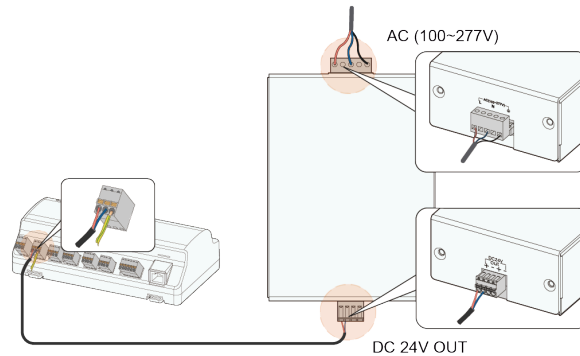

NOTICE

Ensure that the power source meets the requirements for Limited Power Source (LPS) or Power Source 2 (PS2).

--End

5.9 Connecting to the Backend Monitoring System

Connect the Logger1000 to multiple monitoring system platforms to achieve data transmission and remote monitoring.

Using Modbus TCP or IEC104 communication protocols, the Logger1000 can be connected to the backend monitoring system. As a slave device, the Logger1000 allows multiple backends to access, supporting up to 15 Modbus TCP and 15 IEC104 links.

Prerequisite

- Two appropriately sized network cables have been prepared.
- An Ethernet switch is available.

To connect the Logger1000 to multiple monitoring control centers, an Ethernet switch or router can be used.

Using an Ethernet switch as an example:

Step 1 Insert one end of the network cable into the Ethernet switch port, and the other end into the "ETH" port of the Logger1000.

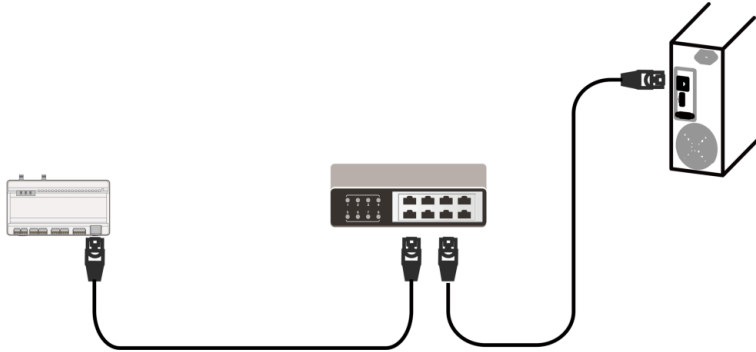

Default IP address of the "ETH" port: 12.12.12.12.

Step 2 Configure the IP address of the Logger1000's "ETH" port so that it is in the same subnet as the backend monitoring system.

--End

5.10 Installing the Micro-SIM Card

To enable wireless communication functions for the Logger1000, install the Micro-SIM card.

Prerequisite

Micro-SIM card size: 12mm x 15mm.

Insert the Micro SIM card into the SIM card slot.

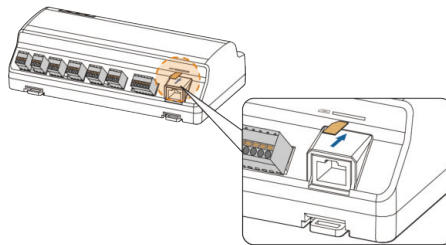

The Micro-SIM card supports hot-plugging.

5.11 Connecting to the Emergency Stop Device

Digital signals from the emergency stop device can be transmitted to the Logger1000.

The DI5 port should only be used for connecting the emergency stop device. The emergency stop device is not included in the scope of delivery.

Connect the signal wire from the emergency stop device to the "DI5" port, and the ground wire to the "0V" port of the Data Logger.

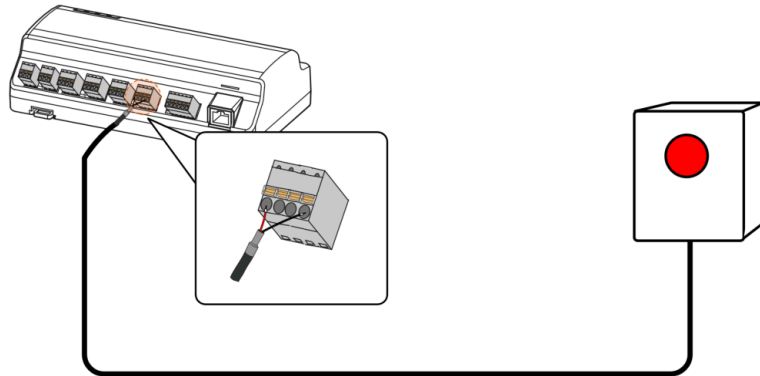

6 Inspection before Commissioning

No.	Check Item	Result
1	All cables are intact, well-insulated, and appropriately dimensioned.	<input type="checkbox"/>
2	All cables are connected correctly and firmly.	<input type="checkbox"/>
3	The polarity of the power supply cable is correct. The grounding cable is reliably grounded.	<input type="checkbox"/>

7 Commissioning

The content presented in this manual, including screenshots, parameters, value ranges, and default values, is intended solely for reference purposes. Always refer to the actual interface for up-to-date and precise information.

7.1 Establishing a Connection

The port for connecting to the local embedded Web via the HTTPS protocol is 443.

When accessing the Logger1000 Web for the first time, you may see the prompt "Your connection is not private." In this case, please click **Advanced** and continue to proceed. Then you can log in to the Logger1000 Web. For how to avoid the prompt of an insecure HTTPS connection, see [20.1 Solution to Insecure HTTPS Connection](#).

7.1.1 Establishing a Connection via Wireless Hotspot

Necessary information for connection

- SSID: SG-[device S/N number] (for example, SG-A1234567890)
- IP address of the Logger1000: 11.11.11.1

Step 1 On your PC, navigate to the wireless network settings, and connect to Logger1000's network.

The serial number (S/N) can be found on the Logger1000's front label.

Step 2 Open your web browser and enter 11.11.11.1 in the address bar to navigate to Logger1000's Web UI.

For LOGGER-SV500.001.00.P007 or later, to log in to the Logger1000 Web system, enter the IP address manually: https://11.11.11.1

--End

7.1.2 Establishing a Connection via Ethernet

Prerequisite

- The Logger1000 is connected to the PC using an Ethernet cable.

Necessary information for login

- Default IP address of the ETH port: 12.12.12.12

- Default subnet mask: 255.255.255.0

Step 1 Set your PC's network card to match the Logger1000's network segment.

For example, assign an IP address to your PC within the same range: 12.12.12.125, with the subnet mask set to 255.255.255.0.

The IP address should have the same first three octets as the Logger1000. The fourth octet should be unique within the range of 1 to 254 to avoid conflicts (excluding 12, which is used by the Logger1000).

Step 2 Open your web browser and enter 12.12.12.12 in the address bar to navigate to Logger1000's Web UI.

For LOGGER-SV500.001.00.P007 or later, to log in to the Logger1000 Web system, enter the IP address manually: `https://12.12.12.12`

--End

7.2 Log in to Web System

Table 7-1 Default Accounts and Passwords

Username	Role	Login Password
maintain	O&M user	pw1111
Defined by the administrator or during account creation	General user	Defined by the administrator during account creation
administrat or	Administrator	pw@111111
develop	Developer	Dynamically generated

A new function "User management" is added to the Web system of Logger1000. For details, see [18 User Management](#).

7.2.1 Local Login

This section provides an example of how to log in to the system as an O&M user.

Step 1 Complete the required information. The actual display may vary.

If...	Then...
Land in the login page of the Web system	<p>Login with an account and password:</p> <ol style="list-style-type: none">Enter the O&M username: maintain.Enter the default password: pw1111.Click Login. <p>Login with verification code:</p> <ol style="list-style-type: none">Enter the O&M username: maintain.Click Verification code login.In the pop-up Back to account + password login window, select Send to owner or Send to retailer/installer, click Get verification code, and enter the received verification code.Click Login.

If...	Then...
	<ul style="list-style-type: none"> • Login with verification code is available on LOGGER-SV500.001.00.P008 or later. • Make sure that the Data Logger is connected to iSolarCloud, and that the serial number of the Data Logger added to the plant is uniquely associated with the owner's or installer's/retailer's email and phone number. • Verification codes are sent via SMS for the Chinese server, and via email for the International server, European server and Australian server. • Each verification code is valid for 5 minutes after being sent. A maximum of 5 code requests is allowed per hour per account. If the verification code is entered incorrectly 6 times in a row, the account will be locked for 10 minutes. During the lockout period, you can still log in using the account name and password.
<p>The General Information page is displayed in the web system</p>	<ol style="list-style-type: none"> a. Click Login in the upper right corner of the page, and a dialog box will then pop up. b. Enter the default password: pw1111. c. Click Login.
<p style="border: 1px solid black; padding: 5px;">If the verification code is entered incorrectly 6 times in a row, the account will be locked for 10 minutes. During the lockout period, when the device is restarted after powering off, the lockout remains, and the duration timer will restart.</p>	

After logging into the Web system, the interfaces for "O&M users" will be displayed.

Step 2 Check Logger1000 for its firmware version and confirm whether an update is needed. For details, see [17.6 Viewing the Firmware Version](#).

For firmware update, see [17.3 Updating the Logger1000](#).

--End

7.2.2 Remote Login via Maintenance Link

Prerequisite

- Remote maintenance is enabled on this Logger1000.
- The necessary maintenance information is provided.

For example, log in as a O&M user:

Step 1 Enter the address <https://rm.isolarcloud.com> in the browser address bar and navigate to the remote maintenance portal.

Step 2 Select the server site and product category.

- Server site: Select as instructed in the remote maintenance information provided.
- Product category: Select communication device.

Step 3 Enter the device S/N and password.

Step 4 Log in and navigate to the Logger1000's login page.

Step 5 Enter the username: maintain.

Step 6 Enter the initial password pw1111, and click **Login**.



After logging in, the Web UI defaults to the interface with O&M user permissions.



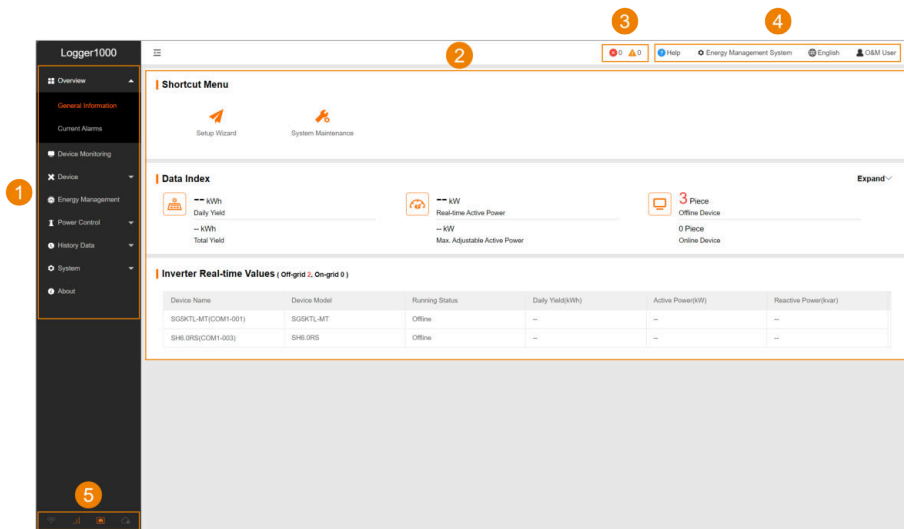

--End

7.3 Overview

7.3.1 Web UI Overview



Position	Name	Description
1	Navigation bar	<ul style="list-style-type: none"> • Overview: View general device information and real-time fault status. • Device Monitoring: Monitor the current operational status of devices in real time. • Device: Manage settings and configurations for connected devices. • Energy Management: Configure the usage strategy for the energy storage system. • Power Control: Control the power output of SUNGROW inverters. • History Data: View history operations. • System: View the system information. • About: View the firmware information.
2	Function area	Display the current page.
3	Alarm bar	Display the number of fault and alarms for the currently connected devices. <ul style="list-style-type: none"> •  : View the number of faults and alarms for inverters.
4	Toolbar	View help information, switch usage scenarios, change interface language, or update personal information.

Position	Name	Description
5	Status bar	Displays the communication status: <ul style="list-style-type: none">  WLAN  Mobile network  Ethernet  iSolarCloud

The Web UI features different usage scenarios, which result in variations in the navigation bars and available functions.

Unless otherwise noted, the following descriptions are based on the permissions of an O&M user.

Upon first logging into the Web UI, the page **Help** appears by default.

7.3.2 Compatibility

Type	Description
Browser	<ul style="list-style-type: none"> Chrome65 or above Safari11 or above
Min. resolution	1024×768

7.4 Modifying Password

It is recommended to change the password after initial login.

Failure to change the default password can lead to unauthorized access, and continued use of the initial password increases the risk of theft and hacking. Additionally, loss of the password can prevent access to the device, potentially causing losses to the plant. In these cases, Sungrow shall not be liable for any losses incurred due to non-compliance with the recommended security practices.

If you forgot password, contact the relevant administrator.

You can reset passwords using one of the following methods:

- Method 1: Log in to iSolarCloud to reset the password.
- Method 2: Log in to the Logger1000 Web with the administrator account and change the passwords for the maintain account and other O&M accounts.
- Method 3: On the Logger1000 Web user login page, click **Forgot password**. In the **Change password** window, obtain the key by scanning the QR code or using the provided link. After entering the key, select the target account type (administrator or maintain), then enter and confirm the new password.

Step 1 Choose **O&M User > Modify Password**.

Step 2 Enter the old password and the new password.

Step 3 Click **Save**.

--End

7.5 Initial Configuration Using the Setup Wizard

Upon your initial login, use the wizard to complete network configuration, grid commissioning, and plant setup.

Prerequisite

- The Logger1000 is able to connect to the Internet.
- The user has O&M user permissions.

During the initial setup process, you can navigate through different configuration items by clicking **Previous** or **Next** as needed.

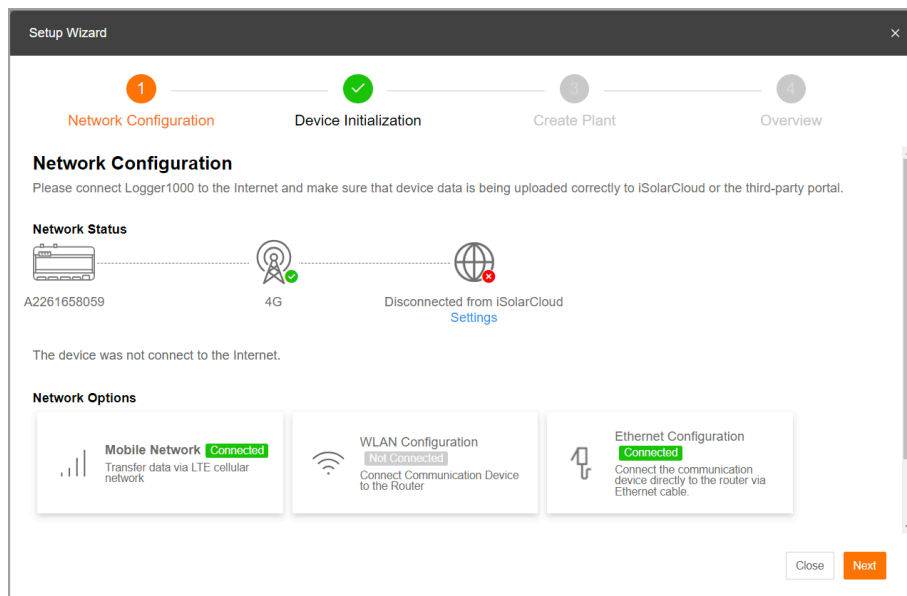

Step 1 Open the **Setup Wizard** dialog box in one of the following ways:

- After the first login or following a reset of the Logger1000, the Web UI will automatically prompt the **Setup Wizard** dialog box.
- On the **Overview > General Information** page, click **Shortcut Menu > Setup Wizard** to open the setup wizard.

Step 2 Configure the network.

The Logger1000 can be connected to the Internet in the following ways:

- **4G**: Confirm a SIM card is inserted, and click **Mobile Network** to establish a cellular network connection.
- **WLAN**: Click **WLAN Configuration**, and under the **Client**, select an available wireless network and enter the password.
- **Ethernet**: Click **Ethernet Configuration**, and modify the Ethernet parameters as needed.

Only Logger1000A supports 4G communication methods.

Step 3 To enable remote web access for maintenance by O&M staff, check **Enable Remote Maintenance**.

Step 4 Click **Next** to proceed to the **Device Initialization** step.

Step 5 Set the system time.

- a. Next to the system time, click **Settings** to select a clock source.

During commissioning, it is recommended to synchronize with the local machine time using **User Define**.

- b. Click **Save**.

Step 6 Click **Auto search** to search for and add available Sungrow inverters and ESSs. Alternatively, you can click **Add device** to manually add Sungrow inverters, meters, meteo stations, ESSs, etc.

- To add an inverter: In the pop-up **Add device** dialog box, select the **Device type**, **Port**, and **Device model**, set the **Beginning address** and **Quantity of device**, then click **Save**.
- To add a meter: In the pop-up **Add device** dialog box, select **Meter** from the **Device type** drop-down list, set the **Access type**, select the **Meter usage**, configure the **Port**, **Device model**, and **Meter address**, then click **Save**.

Step 7 Configure initial parameters for inverters.

- a. Click **Initial Parameter** to open the **Initial Parameter** dialog box.
- b. In the **Country/Region** drop-down list, select the country or region where the plant is located.
- c. In the **Start/Stop** drop-down list, select the operation **Boot** to perform on the inverter.
- d. Click **Settings** to apply the changes.

Step 8 Click **Next** to proceed to the **Create Plant** step.

Step 9 Follow the on-screen instructions, and complete the plant, retailer/installer, and owner information.

A confirmation email will be sent to the designated address upon successful setup.

Step 10 Click **Next** to proceed to the **Overview** step.

In the **Overview** step, you can review the basic configuration of the Logger1000.

Step 11 Click **Initial Report** to export and save the basic configuration locally.

Step 12 Click **Complete**.

--End

You can switch between different usage scenarios for the Logger1000 by selecting the appropriate option in the upper right corner of the Web UI.

7.6 Selecting Usage Scenario of Web UI

After the initial setup, you must select the usage scenario of the Web UI based on actual needs and on-site situations.

Prerequisite

- The user has O&M user permissions.

Usage scenario	Corresponding option on the Web UI	Description
Data acquisition	Data Logger	The Logger1000 does not support energy management. This option is suitable for solar system.
Energy management	Energy Management System	The Logger1000 supports energy management. This option is suitable for energy storage system when integrated with SUNGROW storage inverters and batteries. For detailed instruction, see 15 Energy Management .

Step 1 In the upper right corner of the page, click the option displaying the usage scenario: **Data Logger** or **Energy Management System**.

The name of the option indicates the current scenario of the Web UI.

Step 2 In the drop-down list, select the desired usage scenario.

When the scenario **Energy Management System** is selected, new option **Energy Management** is added to the navigation bar.

--End

8 Configuring Data and Network Interfaces

Configure parameters for interfaces and ports to facilitate seamless data exchange and network communication with connected devices.

Depending on the connection type, the following parameters can be configured:

- RS485
- Ethernet
- Mobile Network
- WLAN
- AI
- DI
- DO

Click **System > Port Parameter** in the navigation bar, from the expanded menu options, select the port type you wish to configure.

8.1 RS485 Communication Ports

To establish successful communication, confirm that the RS485 port settings on the Logger1000 align with those of the connected device.

Step 1 Click **System > Port Parameter > RS485** to navigate to the corresponding page.

Step 2 Select the serial port, and click  to open the **Advanced Settings** dialog box.

Step 3 Enter **Baud Rate**, **Parity Bit**, and **Stop Bit**.

The default configuration is 9600bps, 1 stop bit, and no check bit.

Step 4 Click **Save and Exit** to apply the changes.

--End

8.2 Ethernet

Ensure proper device communication by configuring the Logger1000's network settings.

The default IP address of the ETH port is 12.12.12.12.

If both DHCP and WLAN client are enabled, they must be on different subnets to avoid conflicts.

Step 1 Click **System > Port Parameter > Ethernet** to navigate to the corresponding page.

Step 2 In the drop-down list **Automatically Obtain IP Settings DHCP**, select whether to allow the device to automatically obtain an IP address.

Step 3 If **Automatically Obtain IP Settings DHCP** is enabled, connect to the WLAN module and log in to 11.11.11.1 to view the ETH port's current IP.

Step 4 If **Automatically Obtain IP Settings DHCP** is disabled, manually modify network settings.

The following parameters can be configured:

- **IP Address**
- **Subnet Mask**
- **Default Gateway**
- **DNS1**
- **DNS2**

The port for resolving a domain name to its corresponding IP address via Domain Name System (DNS) is 53.

Step 5 Click  .
--End

8.3 Cellular Network

Ensure that the Logger1000 can be correctly connected to the specified cellular network.

Prerequisite

The Access Point Name (APN) setup has been completed.

Step 1 Click **System > Port Parameters > Cellular Network** to navigate to the corresponding page.

Step 2 Click the **APN Settings** tab, enter the APN in **APN** and configure the **Authentication Type**, **Username**, and **Password** for **Public Network Apn**.

The parameters on the **APN Settings** tab are optional and are not configured by default. To obtain the parameter values, contact the SIM card provider. If the **Authentication Type** is set to **PAP** or **CHAP**, you must enter the username and password.

This feature is available on LOGGER-SV500.001.00.P007 or later.

Step 3 Click **Save**.
--End

8.4 WLAN

Configure the wireless network settings for the Logger1000.

Tab	Description
Client	Used to configure if the Logger1000 should connect to other Wi-Fi hotspots or routers. The WLAN feature is enabled by default.
Hotspot	Used to configure if the Logger1000 should enable its built-in access point to share its mobile data connection with other devices. If AP hotspot enable switch is set to Enable , you can configure the following parameters <ul style="list-style-type: none"> • Network Name: By default, the SSID is set to "SG-[device S/N]" and cannot be changed. • Security <ul style="list-style-type: none"> - None: No password is required for connecting to the hotspot. - WPA2: Set a password to encrypt the network and control access.

If the WLAN hotspot password is changed, you must reconnect to the WLAN network.

Step 1 Click **System > Port Parameter > WiFi** to navigate to the corresponding page.

The **Client** tab page displays.

Step 2 Modify the network settings as needed.

--End

8.5 Analog Input (AI) Port

The Logger1000 has 4 AI ports supporting functions such as active and reactive power control.

Tab	Description
Built-in	Set AI port parameters of the Logger1000
External	Set AI port parameters for external IO device connected to the Logger1000

Step 1 Click **System > Port Parameter > AI** to navigate to the corresponding page.

The **Built-in** tab page displays.

Step 2 Under **Input Type**, select the data type for the sampling signal of different AI ports.

- **Voltage**
- **Current**

Step 3 Depending on the data type, enter the upper and lower limits for the sampling signal in the **Lower Limit** and **Upper Limit** fields.

- Lower limit for voltage: 0~10 V. (Default value: 0)
- Upper limit for voltage: 0~10 V. (Default value: 10)
- Lower limit for current: 4~20 mA. (Default value: 4)
- Upper limit for current: 4~20 mA. (Default value: 20)

Step 4 In the field **Purpose**, describe what the AI port is used for.

Step 5 Click .

Step 6 If the Logger1000 is connected to an external IO device via AI port, click **External** to set the related parameters.

--End

8.6 Digital Inputs (DI) Port

The Logger1000 can be connected to various protective devices within the power plant via Digital Input (DI) ports. Examples of these devices include the Reverse Power Relay (RPR), Ground Fault Overvoltage Relay (OVGR), Undervoltage Protection Relay (UVR), and Earth Leakage Relay (ELR).

Table 8-1 Action description

Action	Inverted action
Boot	Shutdown
Shutdown	Boot
Not Operated	No command will be sent.

Prerequisite

Before setting up the DI parameters, confirm the configurations of the protective devices:

- Normal operation status: **NO** or **NC**
- Status recovery mode: **Manual Control** or **Automatic Control**

Step 1 Click **System > Port Parameter > DI** to navigate to the corresponding page.

Step 2 Configure DI port parameters.

- a. Under **Initial Status**, select the status of this DI port during normal operation.
 - **NO**
 - **NC**
- b. In the **Inverter Action Triggered by DI Recovery** drop-down list, select how the inverter should recover its status.

- **Manual Control:** Manually restores the inverter's status.
 - **Automatic Control:** The Logger1000 issues a command to restore the inverter's status.
- c. Under **Automatic Control**, in the **Inverter Action Triggered by DI Recovery** field, specify the time interval for Logger1000 to wait before sending a command after receiving a DI status recovery signal.
- If no new DI signal change occurs within the set interval, the system will perform the specified **Inverter Action Triggered By DI Action**.
- d. In the **Inverter Action Triggered By DI Action** drop-down list, select the action for the Logger1000 to execute when the DI port status changes.
- **Not Operated:** No command is sent to the inverter.
 - **Boot:** Power-on commands are sent to the inverter.
 - **Shutdown:** Power-off commands are sent to the inverter.
- e. In the **Action Delay Time After DI Action** field, set the time interval for the Logger1000 to wait before sending a command in response to a DI status change.
- If no new DI signal change occurs within the set interval, the system will perform the specified **Inverter Action Triggered By DI Action**.
- f. In the **Purpose** field, describe what the DI port is used for.
- g. In the **Alarm enable/disable** drop-down list, select whether to trigger the Logger1000 to transmit alarm information to the iSolarCloud when the statuses of the DI ports change. By default, the alarm switches for DI1–DI4 are set to **Enable**.
- **Enable:** Transmit alarm information to the iSolarCloud.
 - **Disable:** Do not transmit alarm information to the iSolarCloud.

This feature is available on LOGGER-SV500.001.00.P008 or later.

- h. In the **Alarm level** drop-down list, set the alarm levels triggered by the Logger1000 when the statuses of the DI ports change. Options include Prompt, advice, Alarm, and Fault. By default, the alarm levels for DI1–DI4 are set to **Prompt**.

This feature is available on LOGGER-SV500.001.00.P008 or later.

Step 3 Click **Save**.

--End

8.7 Digital Output (DO) Port

The DO port parameters can be configured if an external IO module is used.

Table 8-2 Status Description

Status	Inverted Status
NO	NC

Status	Inverted Status
NC	NO

Step 1 Click **System > Port Parameter > DO** to navigate to the corresponding page.

Step 2 Configure DO port parameters.

- a. Under **Initial Status**, select the status of the DO port during normal operation.
 - **NO**
 - **NC**
- b. In the drop-down list **Function**, select the method to control the DO port.
 - **Communication Control**: Send commands via iSolarCloud or a third-party device.
 - **Manual Control**: Manually control the status of the DO port via the Web UI.
- c. In the drop-down list **Action Mode**, select the action after the DO port status changes.
 - **Level**: The DO port status remains changed.
 - **Pulse**: The DO port status returns to the initial status after holding the changed status for a period of time.
- d. Only when **Action Mode** is set to **Pulse**, can you configure **Pulse Duration**.
- e. In the field **Purpose**, describe what the DO port is used for.

Step 3 In the mode **Manual Control**, set the corresponding parameters.

- a. In the upper right of the page, click **Manual Control**.
- b. In the drop-down list **Control Method**, select the action after the DO status changes.
 - **Reset**: The DO port status returns to the initial status.
 - **Action**: The DO port status changes to the inverted status of **Initial Status**.
- c. Click **Confirm**.

Step 4 Click  .

--End

9 Configuring Data Communication and Transfer Protocols

Forward device data to the remote or local monitoring systems.

The following data communication and transfer methods are supported to transmit collected data to the designated monitoring system.

- iSolarCloud
- IEC104
- Modbus
- Third-party portal
- Echonet

The following minimum system functions can be maintained under attacks:

- Modbus RTU forwarding for one southbound device.
- Modbus RTU data collection for one device.

Step 1 Click **System > Transfer Configuration** to navigate to the corresponding page.

By default, the iSolarCloud configuration page displays.

Step 2 Select a tab that suit your communication protocol, and configure the parameters accordingly.

--End

9.1 Setting iSolarCloud Parameters

Transfer the collected data to iSolarCloud.

To ensure the Logger1000 can function properly, please complete the router whitelist settings first. For details, see [Router Whitelist Settings](#).

Step 1 Click the **iSolarCloud** tab.

Step 2 Turn on the switch to enable data transfer using iSolarCloud.

Step 3 Click  to open the **Advanced Settings** dialog box.

a. In the drop-down list **Server**, select the server according to the power plant's location.

- The default iSolarCloud server is a general server (iot.isolarcloud.com).
- Users in mainland China select "**Chinese Server**".
- Users in Europe select "**European Server**".
- Users in Australia select "**Australian Server**".

- Users in other regions select "**International Server**".
 - b. If there is no need to retrieve device data during nighttime, check **Night Silence** and set the start and end times.
 - c. Click **Save**.
- End

9.2 Setting IEC104 Parameters

Transfer the collected data to the monitoring system using the IEC104 protocol.

• **Server Mode**

The Logger1000 acts as a server, responding to requests from client devices within the network.

The IEC104 protocol uses port 2404.

• **Client Mode**

The Logger1000 operates as a client that initiates requests and commands to the server devices.

9.2.1 IEC104 Forwarding Table

When using the IEC 104 communication protocol, a forwarding table needs to be configured to specify the data items and address information that need to be forwarded.

Hybrid inverters do not support configuring the IEC 104 forwarding point list parameters.

Table 9-1 Description of the forwarding table

Sheet	Description
Introduce	Explains the abbreviations for the five types of data: telemetry, telesignalling, remote pulse, remote control, and remote regulating.
Cfg Para	<ul style="list-style-type: none"> • View and modify the beginning addresses of the five types of data (Bngr Addr). • The addresses displayed in the table are default and can be adjusted as needed based on the actual situation.
Device List	<ul style="list-style-type: none"> • View the devices. Related parameters can be configured. • The order of devices can be rearranged by dragging and dropping entire rows to the desired positions.

Sheet	Description
Device's Name	<p>Set the measuring data for devices such as inverter, Smart Energy Meter, Meteo Station, and Logger1000.</p> <div style="border: 1px solid black; padding: 5px;"> <p>Due to the differences in communication protocols, the names of the data points forwarded in compliance with IEC 104 may not be exactly consistent with those displayed on the Logger1000 Web. The definitions and explanations of all remote data points shall be subject to the IEC 104 forwarding point list.</p> </div>

Table 9-2 Device List sheet

Parameter	Description
Device Type	Device type
Com ID	The number of COM port to which device connected, corresponding to the information on the page Device List . The parameters should be set according to on-site conditions.
Collect ID	Collect device's Modbus address, corresponding to the communication address on the page Device List . The parameters should be set according to on-site conditions.
Access ID	The background access address, corresponding to the forwarding address on the Device List page. The parameters should be set according to on-site conditions.
Template Sheet	The name must match the corresponding name in the working sheet of the device.
Reserved YX Addr	Reserved telesignaling address
Reserved YC Addr	Reserved telemetry address
Reserved YM Addr	Reserved remote pulse address
Reserved YK Addr	Reserved remote control address
Reserved YT Addr	Reserved remote regulating address

9.2.2 Setting IEC104 Parameters Using Forwarding Point List

To apply the default setting of the forwarding point list to port 2404, click **Generate Point Table**.

To customize the forwarding point list:

Step 1 Export the forwarding point list.

- a. Select the tab **Server**.
- b. Click **Generate Point Table**.

This operation will generate the device list data in the .xslm template from the export configuration tool, as in next step, and overwrite all existing point lists on port 2404.

- c. Click **Export of Configuration Tools** to download the IEC104 forwarding point list locally.

The forwarding point list is in the .xslm format.

Step 2 Open the IEC104 forwarding point list using Microsoft Excel, and modify the data according to the actual requirements.

Step 3 Save the forwarding point list in Excel.

Step 4 Import the forwarding point list back.

- a. In the Excel menu bar, select **IEC104 > IEC104 CFG**.

An Excel macro command will process and convert the .xslm file into a .xml file. The generated .xml file, along with the original .xslm file, will be located in the same file directory.

- b. Return to the web UI, navigate to the **IEC104 > Server** page, and click  to open the **Advanced Settings** dialog box.

- c. Under **Configuration File**, click , and follow the on-screen instructions to complete the .xml file import.

Step 5 Click **Save**.

Step 6 (Optional) Export the IEC104 forwarding point list.

- For port 2404, only the first step is needed to export the forwarding point list.
- For ports other than 2404, you need to go through the steps 1 to 5. After opening the specific port you want to export, click the icon  of that port.

--End

9.2.3 Setting Communication Interruption Protection

If you're using the IEC104 protocol for communication with inverters, you can set restrictions on the power output ratio in case of communication failure.

Step 1 Navigate to the page **IEC104 > Server**, and click **Communication Interrupted Protection** to open the **Communication Interrupted Protection** dialog box.

Step 2 Set **Protection Switch** to **Enable**.

Step 3 Configure the following parameters.

- **Peer IP Address:** The IP address of the peer device.
- **Port:** The port number of the peer device.
- **Instruction Valid Period:** Specify the duration after which interrupted communication is considered abnormal.
- **Communication Abnormality Output:** Specify the percentage of power that should be dispatched during communication abnormalities.

Step 4 Click 

--End

9.2.4 Restricting IEC104 Communication to Authorized Devices

To enhance security and control over the Logger1000, you can specify which devices are permitted to establish IEC104 protocol communication by creating a whitelist of approved IP addresses.

Prerequisite

- The IP addresses of the specified devices are known.

If no whitelist is configured, the Logger1000 accepts connections from any valid IP address. The default IP address is 0.0.0.0.

Step 1 Navigate to the page **IEC104 > Server**, and click **White List Setting** to open the **White List Setting** dialog box.

Step 2 Check **Enable White List**.

Step 3 Under the column **Peer IP Address**, enter the IP addresses of the devices that are authorized.

Step 4 Click **Save**.

--End

9.2.5 Adding a Peer Device

If a third-party device is added to function as a server, update the device information accordingly.

Step 1 Generate and edit the forwarding table.

See [9.2.2 Setting IEC104 Parameters Using Forwarding Point List](#).

Step 2 Return to the web UI, navigate to the **IEC104 > Client** page, and click  to open the **Advanced Settings** dialog box.

Step 3 Enter relevant information for the peer device.

- **Server:** Enter the domain name of the master station server.

- **Peer Port:** Enter the port number of the master station server.

Review and adjust any other settings to fit your requirements, or keep the default configurations if they suit your needs.

Step 4 Under **Configuration File**, click , and follow the on-screen instructions to complete the import of the .xml file.

Step 5 Click **Save**.

--End

9.2.6 Configuring SSL Encryption

The ports used by the IEC104 forwarding service support SSL encryption. Users can enable or disable SSL encryption via the Web user interface.

This feature is available on LOGGER-SV500.001.00.P007 or later.

Step 1 Navigate to **System > Forwarding Configuration**, and click **IEC104**.

Step 2 Choose the **Server** tab. Here, you can enable or disable **SSL Encryption** for the local port.

Ports 2404 to 2418 are used for the IEC104 forwarding service. Port 2418 is enabled by default with SSL encryption activated. The other ports are disabled by default, and SSL encryption is also disabled. Users can manually enable or disable the port and SSL encryption.

If non-secure ports are used:

- If SSL encryption is enabled: When enabling the port manually, no security warning will appear.
- If SSL encryption is disabled: When enabling the port manually, a message will appear indicating that the protocol is insecure and risky. Verify that the device is operating on a secure network before enabling the port.
- When manually disabling SSL encryption for an enabled port: A message will appear stating that this protocol is risky. Verify that the device is operating on a secure network before disabling SSL encryption.
- When enabling SSL encryption for an enabled port: No security warning will appear.
- When the port is disabled: Actions on the SSL Encryption button will not trigger a security warning.

--End

9.3 Setting Modbus Parameters

Transfer the collected data to the monitoring system using the Modbus protocol.

- **Server Mode**

The Logger1000 acts as a server, responding to requests from client devices within the network using the Modbus TCP protocol.

- **Client Mode**

The Logger1000 operates as a client that initiates requests and commands to the server devices using the Modbus TCP protocol.

- **RTU Mode**

The Logger1000 acts as a server, responding to requests from client devices within the network using the Modbus RTU protocol.

- When Logger1000 (firmware version: P043 or later) works in "Server" or "RTU" mode, Address for Modbus Forwarding is required if the user wants to acquire data through third-party monitoring. Click **Device > Device List** to navigate to the corresponding page. Obtain the forwarding address of the device in the **Address for Modbus Forwarding** column.
- When configuring the Modbus TCP data forwarding function, ensure that the Modbus forwarding address defined in the current device must match exactly with that of the Modbus slave station in the target device. If the addresses mismatch, the master device cannot properly read data of the target device.

When forwarding or configuring the parameters of the 4x-type holding register in the southbound devices, it is recommended to set the intervals of northbound collection and control to at least 10 seconds. This helps ensure that the data is refreshed stably and that the collection process is not disrupted.

9.3.1 Setting Communication Interruption Protection

If you're using the Modbus protocol for communication with inverters, you can set restrictions on the power output ratio in case of communication failure.

Step 1 Navigate to the page **MODBUS > Server**, and click **Communication Interrupted Protection** to open the **Communication Interrupted Protection** dialog box.

Step 2 Set **Protection Switch** to **Enable**.

Step 3 Configure the following parameters.

- **Peer IP Address:** The IP address of the peer device.
- **Port:** The port number of the peer device.
- **Instruction Valid Period:** Specify the duration after which interrupted communication is considered abnormal.
- **Communication Abnormality Output:** Specify the percentage of power that should be dispatched during communication abnormalities.

Step 4 Click 
--End

9.3.2 Restricting Modbus Communication to Authorized Devices

You can also specify which devices are permitted to establish Modbus protocol communication by creating a whitelist of approved IP addresses.

Prerequisite

- The IP addresses of the specified devices are known.

Step 1 Navigate to the page **MODBUS > Server**, and click **White List Setting** to open the **White List Setting** dialog box.

Step 2 Check **Enable White List**.

Step 3 Under the column **Peer IP Address**, enter the IP addresses of the devices that are authorized.

Step 4 Click **Save**.

--End

9.3.3 Adding a Peer Device

If a third-party device is added to function as a server, update the device information accordingly.

Step 1 Navigate to the **MODBUS > Client** page, and click  to open the **Advanced Settings** dialog box.

Step 2 Enter relevant information for the peer device.

- **Server**: Enter the domain name of the master station server.
- **Peer Port**: Enter the port number of the master station server.

Step 3 Click **Save**.

--End

9.3.4 Configuring Serial Port Parameters

When operating in Modbus-RTU mode, you can configure the serial port parameters to facilitate data communication and forwarding with third-party devices.

Prerequisite

- There are unoccupied COM ports can be configured.

Step 1 Click **MODBUS > RTU** to navigate to the corresponding tab page.

Step 2 In the drop-down list **Serial Port Name**, select the COM port to be configured.

If **Forwarding Is Prohibited** is selected, the Logger1000 will only collect data from the device connected to this port, and will not forward it.

A maximum of two COM ports can be used for data forwarding.

Step 3 In the field **Delay**, enter the desired time interval for the commands to be sent.

--End

9.3.5 Configuring SSL Encryption

The ports used by the Modbus forwarding service support SSL encryption. Users can enable or disable SSL encryption via the Web user interface.

This feature is available on LOGGER-SV500.001.00.P007 or later.

Step 1 Navigate to **System > Forwarding Configuration**, and click **Modbus**.

Step 2 Choose the **Server** tab. Here, you can enable or disable **SSL Encryption** for the local port.

Ports 502 to 516 are used for the Modbus forwarding service. Port 516 is enabled by default with SSL encryption activated. The other ports are disabled by default, and SSL encryption is also disabled. Users can manually enable or disable the port and SSL encryption.

If non-secure ports are used:

- If SSL encryption is enabled: When enabling the port manually, no security warning will appear.
- If SSL encryption is disabled: When enabling the port manually, a message will appear indicating that the protocol is insecure and risky. Verify that the device is operating on a secure network before enabling the port.
- When manually disabling SSL encryption for an enabled port: A message will appear stating that this protocol is risky. Verify that the device is operating on a secure network before disabling SSL encryption.
- When enabling SSL encryption for an enabled port: No security warning will appear.
- When the port is disabled: Actions on the SSL Encryption button will not trigger a security warning.

--End

9.4 Setting Parameters for Third-Party Portal

Transfer the collected data to a third-party monitoring system.

Prerequisite

- There is an available FTP/SFTP server.

Step 1 Click the **Third-party Portal** tab.

Step 2 Turn on the switch to enable data transfer using an FTP or SFTP server.

Step 3 Click  to open the **Advanced Settings** dialog box.

Step 4 Update the configuration details.

The following parameters can be configured:

- **Server:** Enter the address or domain of the server.
- **Protocol Type:** Enter the protocol for data transfer.
 - **FTP:** Use the FTP protocol for standard data transfer scenarios.
 - **SFTP:** Use the SSH protocol for encrypted data transfer, suitable for scenarios requiring data security.

- **Peer Port:** Enter the communication port for the server. The default port for FTP is 21. The default port for SFTP is 22.
- **Account:** Enter the username or account to log in to the FTP/SFTP server.
- **Password:** Enter the password required for server access.
- **FTP Path:** Name the folder in the format “/FTP server directory”. For example, in “/SUNGROW”, “/” denotes the root directory, and “SUNGROW” is the directory on the FTP server where data is stored.
- **Sampling Cycle:** Determine the frequency of data collection from the Logger1000.
- **Transmission Cycle:** Specify how often data is uploaded to the FTP/SFTP server.
- **RFC3339:** Specify the timestamp format to use in data transfers.

Step 5 Click **Save**.

--End

9.5 Setting Modbus Parameters

Transfer the collected data to the monitoring system using the Modbus protocol.

- **Server Mode**
The Logger1000 acts as a server, responding to requests from client devices within the network using the Modbus TCP protocol.
- **Client Mode**
The Logger1000 operates as a client that initiates requests and commands to the server devices using the Modbus TCP protocol.
- **RTU Mode**
The Logger1000 acts as a server, responding to requests from client devices within the network using the Modbus RTU protocol.

- When Logger1000 (firmware version: P043 or later) works in "Server" or "RTU" mode, Address for Modbus Forwarding is required if the user wants to acquire data through third-party monitoring. Click **Device > Device List** to navigate to the corresponding page. Obtain the forwarding address of the device in the **Address for Modbus Forwarding** column.
- When configuring the Modbus TCP data forwarding function, ensure that the Modbus forwarding address defined in the current device must match exactly with that of the Modbus slave station in the target device. If the addresses mismatch, the master device cannot properly read data of the target device.

When forwarding or configuring the parameters of the 4x-type holding register in the southbound devices, it is recommended to set the intervals of northbound collection and control to at least 10 seconds. This helps ensure that the data is refreshed stably and that the collection process is not disrupted.

10 Device Administration

10.1 Adding SUNGROW Inverters

SUNGROW inverters can be automatically recognized on the Web UI, with unique addresses assigned to each inverter.

Prerequisite

- The inverters can be identified by a serial number.
- The Logger1000 is correctly connected to the SUNGROW inverters.

If there is an address conflict, you will be prompted with a message.

Step 1 Navigate to the page **Device > Device List**, and click **Auto Search** to open the **Auto Search** dialog box.

Step 2 To view and filter inverters connected to a specific COM port, in the drop-down list **Port**, select the corresponding COM port.

--End

10.2 Adding a Third-Party Device

10.2.1 Selecting Device

Prerequisite

- The Logger1000 is connected to the device.
- The port parameters of this device has been configured.

Take adding a third-party meter as an example:

Step 1 Navigate to the page **Device > Device List**, and click **Add Device** to open the **Add Device** dialog box.

Step 2 In the drop-down list **Device Type**, select the device type.

Step 3 In the drop-down list **Access Type**, select the meter type according to its actual installation location.

- **Electricity Meter**: Used to monitor power consumption on the inverter side.
- **Gateway Meter**: Used to monitor power consumption on the grid side.

Step 4 In the drop-down list **Port**, select the port that the meter is connected to.

--End

10.2.2 Importing Device Information by Setting Measuring Points

For measuring point configuration templates, contact SUNGROW.

Step 1 In the drop-down list **Device Model**, select **Others**.

Step 2 In the drop-down list **Configuration Method**, select **Custom**.

Step 3 Click **Next** to open the **Configure Measuring Point** dialog box.

--End

10.2.2.1 Verifying Measuring Point Data

- Check the measuring points, and click **Read-back**.
If the values retrieved match the real-time display values from the third-party device, this confirms that the measurement points are configured correctly.

10.2.2.2 Saving Configuration as Template

By saving the previous modified measuring points configuration as a template, you enable a quicker and more efficient setup when dealing with third-party device settings in the future.

Prerequisite

- Ensure that the current measuring point parameters are configured configured.

Step 1 In the dialog **Configure Measuring Point**, click **Save Template** open the dialog.

Step 2 In the field **Template Name**, enter a descriptive name for the template.

The template name should be a combination of numbers, letters, dashes and underscores starting with English letters, with a maximum length of 32 bits.

Step 3 Click **Confirm** to save the template.

Step 4 In the dialog **Configure Measuring Point**, click **Confirm** to save the configuration of measuring points.

--End

10.2.3 Importing Device Information Using a Configuration File

Prerequisite

- The device type and its corresponding connected port have been selected. See [10.2.1 Selecting Device](#).
- There are available measuring point configuration templates or a .xml configuration file.

Step 1 In the drop-down list **Device Model**, select **Others**.

Step 2 In the drop-down list **Configuration Method**, select **Import Files**.

Step 3 In the drop-down list **Configuration File**, select the relevant measuring point template, or click  to import the .xml configuration file.

Step 4 In the field **Beginning Address**, enter the beginning address of the device.

Step 5 In the field **Quantity of Device**, enter the number of devices added to the current port.

If multiple devices are added to the same port, ensure that the **Beginning Address** is greater than the existing ones to avoid conflicts.

Step 6 Click **Save**.

--End

10.3 Enabling Optimizer/RSD Connection

This feature is available on LOGGER-SV500.001.00.P008 or later.

Step 1 Log in to the Logger1000 Web and choose **Device maintenance > Device list**.

Step 2 Click **Connect optimizer/RSD**. In the pop-up dialog box, select the inverters for which you want to enable optimizer/RSD connection.

Step 3 Click **Settings**.

Alternatively, you can select **Installed optimizer/RSD** in the **Setup wizard**. Once enabled, all connected inverters will support optimizer/RSD connection.

--End

10.4 Configuring Device Parameters

10.4.1 Configuring Parameters for Inverters

View the inverter's real-time data and related parameters. You can adjust the settings of an individual inverter, or apply configurations to multiple inverters.

NOTICE

To maintain optimal performance and ensure safety, the inverter parameters must be configured by qualified personnel. Incorrect settings may lead to disconnection from the grid and impact energy yield.

NOTICE

Only SUNGROW inverter supports setting parameters via the Web UI.

Types of Parameters	Description
Initial Parameter	Select the country or region where the power plant is located.
Operation Parameters	Used to adjust the inverter's performance and operational behavior.
System Parameters	Used to set the inverter's time.

Types of Parameters	Description
Protection Parameters	Used to adjust standard protection measures and responses for general abnormal conditions.
Protection Parameters (Others)	Used to configure additional protections for specific abnormal scenarios.
Power Regulation Parameters	Used to adjust parameters related to grid dispatching.
Energy Management Parameters	Used to adjust parameters related to energy management. Only displayed for hybrid inverters.
General Parameters	Used for other general settings of the inverter.

- Step 1** Click **Device Monitoring** to navigate to the corresponding page.
- Step 2** From the device list on the left, select the inverter you wish to configure.
- Step 3** Refer to the inverter's user manual and follow the on-screen instructions to adjust the inverter's operating parameters accordingly.
- Step 4** Click **Settings** to apply the changes.
- Step 5** Apply configurations to multiple inverters.
- a. Click **Configure Synchronization**.
 - b. Select the inverters you want to configure in the pop-up dialog, and click **Save**.
- End

10.4.2 Configuring Parameters for Meter

- Step 1** Click **Device Monitoring** to navigate to the corresponding page.
- Step 2** From the device list on the left, select the meter you want to configure.
- Step 3** On the right, select the tab page **Initial Parameter** to modify the meter's initial parameters.
- **PT Transformation Ratio:** Enter the turns ratio of the power transformer.
 - **CT Transformation Ratio:** Enter the turns ratio of the current transformer.
 - **Meter Reverse Connection Enable:** Use this setting if the meter cables are confirmed to be connected in reverse. It allows the meter to report accurate data. Both single-phase and three-phase meters can be configured for reverse connections. For three-phase meters, the setting is valid only if all three phases are reversed. Partial reverse connection (one or two phases) is not supported.
 - **Open:** The meter cables are currently connected in reverse.
 - **Close:** The meter cables are correctly connected.
 - **Access Type** Select the meter type according to its actual installation location.
 - **Meter Usage:** Select the meter's purpose based on its actual installation location and the usage scenario.
- Step 4** Click **Settings** to apply the changes.

--End

10.4.3 Configuring Parameters for Batteries

Prerequisite

- The SUNGROW inverter, equipped with a battery unit, is connected and operational.

Step 1 Click **Device Monitoring** to navigate to the corresponding page.

Step 2 From the device list on the left, select the battery associated with the inverter.

Step 3 Refer to the battery's user manual and follow the on-screen instructions to adjust the battery's operating parameters accordingly.

The following parameters can be configured:

- **Cut-off SOC of Discharge**: Specify the SOC level below which the battery should stop discharging.
- **Emergency Charging SOC**: Specify the SOC level below which the battery should begin forced charging.

Step 4 Click **Settings** to apply the changes.

--End

10.4.4 Setting Meteo Sensor Parameters

Step 1 Choose **Device Maintenance** in the navigation bar.

Step 2 Select "Meteorological Sensor" from the device list on the left.

Step 3 Choose the **Initial Parameter** tab to modify the settings of initial parameters for the meteo sensor.

- **Instantaneous Horizontal Irradiance (W/m²)**: Select the AI port. Specify the upper and lower limits for instantaneous horizontal irradiance, in a range of 0 to 2000. The default value is 0.
- **Instantaneous Slope Irradiance (W/m²)**: Select the AI port. Specify the upper and lower limits for instantaneous slope irradiance, in a range of 0 to 2000. The default value is 0.
- **Ambient temperature (°C)**: Select the AI port. Specify the upper and lower limits for the ambient temperature, in a range of -100 to 100. The default value is 0.
- **Module temperature (°C)**: Select the AI port. Specify the upper and lower limits for the module temperature, in a range of -100 to 100. The default value is 0.

For **LOGGER-SV500.001.00.P007** or later, you can configure the same parameter across multiple AI ports simultaneously. For example, you can configure the **Module Temperature** on A1, A2, A3, and A4 ports at the same time.

Step 4 Click **Save**.

--End

10.4.5 Correcting Cumulative Power Generation

During operation, Rapid Shutdown Devices (RSDs) monitor the cumulative power generation data of the solar panels they are connected to. If an RSD fails and is replaced, the new device must be configured to continue monitoring data from the point recorded by the old device. O&M personnel can manually input and update the cumulative power generation data from the old device via the Web UI, ensuring continuity and accuracy of the data.

Prerequisite

- The RSD replacement has been completed.

When using the device replacement feature in iSolarCloud, the cumulative power generation data can be automatically corrected. For detailed instructions, see iSolarCloud App User Manual.

Step 1 Click **Device Monitoring** to navigate to the corresponding page.

Step 2 In the device list on the left, select the connected RSD, then click the tab **RSD Parameter** on the right.

Step 3 In the field **PV Module Total Yield Adjustment**, enter the actual cumulative power respective module as recorded.

Step 4 Click **Settings** to apply the changes.

--End

10.5 Automatic Frequency Point Assignment

Frequency point assignment involves assigning specific communication frequencies to devices to ensure that data is exchanged smoothly between them. Before connecting inverters to the network, it helps prevent signal interference between devices, ensuring the accuracy of data acquisition.

Step 1 Click **Device > Device List** to navigate to the corresponding page.

Step 2 Click **Automatic Frequency Point Assignment** to open the dialog box **Select Measuring Points**.

Step 3 From the drop-down menu, select the frequency points as indicated, ensuring they meet the required range and count.

Step 4 Click **Confirm**.

--End

10.6 Uploading Physical Layout

In environments lacking network connectivity, it's essential for O&M personnel to upload the physical layout configurations of devices like inverters via the Web UI. This step ensures devices are correctly recognized and managed on the platform.

Step 1 Click **Device > Device List** to navigate to the corresponding page.

- Step 2** Click **Topology White List** to open the **Topology Information** dialog box.
- Step 3** Download the template in .xlsx format to your local computer.
- Step 4** Edit the layout template.
- Open this template with Excel and follow the provided instructions to fill out the device numbers and serial numbers (S/N).
 - Save your modifications.
- Step 5** Upload the configuration.
- Return to the Logger1000's Web UI and in the dialog box **Topology Information**, click **Select File**.
 - Browse to the file location through the file explorer window that pops up and select the updated template file.
 - Click **Open** to upload the file and confirm the upload.
 - In the dialog **Topology Information**, click **Import**.
Once uploaded, the Web UI will automatically check the file for accuracy.
 - If any errors are detected, refer to the on-screen prompts to make necessary corrections to the template file and upload it again.
- End

10.7 Controlling SUNGROW Inverter

The Web UI enables you to remotely power SUNGROW inverters on or off and perform a reset.

NOTICE

Delivering a reset or shutdown to the inverter may lead to disconnection from the grid and impact energy yield.

Take powering on the inverter as an example:

- Step 1** Click **Device Monitoring** to navigate to the corresponding page.
- Step 2** In the device list on the left, select the inverter, then click the tab **Device Instruction** on the right.
- Step 3** Click **Boot** to open the dialog box.
- Step 4** Click **Yes** to confirm and apply the power-on to the individual inverter.
- Step 5** Batch powering on inverters.
- In the pop-up window, click **Configure Synchronization** to display the device list.
 - Select the inverters you want to power on, and click **Save**.
A dialog will appear to confirm the result.
- End

10.8 Editing Device Information

Step 1 Click **Device > Device List** to navigate to the corresponding page.



Step 2 Click  to open the **Edit Device** dialog box.

Step 3 Modify the device information.

- **Device Name:** Edit the device name. The default naming convention is "Device model (port number-communication address)", such as "SG36KTL-M(COM1-7)".
- **Device Address:** The communication address of the device. It is only modifiable for SUNGROW inverter.
- **Address for Modbus Forwarding:** Integer, ranging from 1 to 246; used for data forwarding in Modbus TCP and Modbus RTU modes (this parameter is available for Logger1000 P043 or later).
- **Instruction Interval Time:** Specify the time interval between sending two consecutive commands.
- **Timeout Value:** Specify the maximum wait time for the device to respond to a command.
- **Repeat Times:** Specify the number of attempts to resend the command if a communication timeout occurs.

Step 4 Click **Save**.

Step 5 Batch modify names for multiple devices.

- a. Click  to download the general information of added devices locally. The file is in a .csv format.
- b. Edit the device names as needed.
- c. Click  to import the file.

--End

10.9 Updating Devices

You can update the firmware for SUNGROW inverters.

Prerequisite

Prepare the necessary files or configurations based on your chosen update method:

- Update locally
- Update online
- Update via iSolarCloud See [9 Configuring Data Communication and Transfer Protocols](#).

When remotely updating or downgrading the intelligent modules of Logger1000 via iSolarCloud, do not execute an update or rollback in the Logger1000 Web system.

For the required tools and resource files for the update, contact SUNGROW.

The local update package must be in .zip or .sgu format.

The update process cannot be interrupted once it has begun.

Step 1 Click **Device > Firmware Update** to navigate to the corresponding page.

Step 2 Click **Select a Firmware File** to select an update method.

The following update methods are supported:

- **Local Update Package:** In the resource window, choose the firmware file and verify the matching devices.
- **Online Update Package:** Obtain the firmware package through the iConfig tool and proceed with the update.
- **iSolarCloud Upgrade Package:** Use the online firmware package available through iSolarCloud to update the device.

Step 3 Follow the on-screen instructions to complete the update process.

--End

After updating, you can view details such as the current firmware version, target version number, and the time of the update.

10.10 Removing Devices

If the device is no longer needed on site, remove it on the web UI.

Step 1 Click **Device > Device List** to navigate to the corresponding page.

Step 2 Check the device to be deleted, and click **Delete**.

Step 3 In the pop-up dialog, click **Confirm**.

--End

10.11 Device Self-Test

Prerequisite

Ensure inverters and batteries have been connected.

- This function is available on LOGGER-SV500.001.00.P012 or later.
- Currently, only battery charging and discharging tests are supported.
- If the connected inverter or battery is offline, the self-test will fail.
- If power loss occurs on the data logger during the self-test, the system automatically saves the self-test status.

Step 1 Choose **Device maintenance > Self-test**.

Step 2 Click **Start self-test**.

Step 3 Click **Confirm** in the pop-up dialog box.

During the self-test, the system's energy management mode switches to **Forced mode** and automatically returns to the original mode after the self-test is completed.

During the process, the total remaining time, overall progress, and the status of each inverter are displayed in real time.

Step 4 After completion, a success message is displayed. If the self-test fails, the specific cause of failure and recommended actions are displayed. To perform the self-test again, click **Restart self-test**.

--End

10.12 Enabling Arc Fault Circuit Interrupter (AFCI) Function

Prerequisite

- The currently added inverters support self-checks.

Step 1 Click **Device > AFCI Activation** to navigate to the corresponding page.

Step 2 In the drop-down list **Status**, set the status to **Enable** to enable the self-check.

Step 3 In the pop-up dialog, select **Settings** to confirm to enable self-checking.

Step 4 Check the inverters you wish to set for self-checking, and click **Self Checking**.

Step 5 In the pop-up dialog, click **Confirm**.

The self-check status will be updated to "Self-Testing".

Step 6 If the self-check status is updated to "Self-checking Failure", click **Clear Fault**.

--End

10.13 Configuring Cascaded Scheduling

Cascaded Scheduling is available on LOGGER-SV500.001.00.P007 or later.

In the cascaded dispatch mode, it is not currently supported to control the chargers.

Step 1 Navigate to **Device Maintenance > Device List**.

Step 2 Click **Add Device** and set **Device Type** to SUNGROW Logger in the pop-up window.

Step 3 Select the status of host-client scheduling control in **Cascaded Scheduling**.

- **Enable:** Enable Cascaded Scheduling, where the client Logger1000 is subject to the control by the host Logger1000. Multiple Logger1000 devices are cascaded and the current Logger1000 serves as the host.

In Cascaded Scheduling mode, to use a client Logger1000 device for energy management or power regulation, first log in to the host Logger1000 in the system and disable Cascaded Scheduling for that client.

- **Disable:** Disable Cascaded Scheduling, where the client Logger1000 is not controlled by the host Logger1000. All inverters are connected to the same Logger1000 device and the inverters must all be string inverters or central inverters.

--End

11 Device Monitoring

11.1 Viewing Power Plant and Device Operation Information

Power Plant Operation

On the page **Overview > General Information**, you can view the basic information of the power plant.

- **Data Index:** Displays crucial operational data such as today's energy production, total energy production, and real-time active power output.
- **Inverter Real-time Values:** Displays the status and performance metrics of the inverter equipment.

Device Information



On the page **Device Monitoring**, you can view the basic information of devices.

Depending on the type of connected device, you can access various information:

- **Realtime Values**
- **DC Info**
- **Device Information**
- **Battery Information**

On the page **Device Monitoring** or **Device > Device List**, you can view the communication status of the device.

Table 11-1 Device communication status

Icon	Description
	Device communication is normal.
	Device communication is abnormal

11.2 Viewing Alarms

- Click **Overview > Current Alarms** to navigate to the corresponding page.
Monitor the live status of alarm events.

12 Exporting Data

12.1 Exporting Logs of Connected Devices

The Web UI supports exporting logs from inverters and other devices.

Prerequisite

- The status of the device must be “connected”.

Step 1 Click **Device > Inverter Log** to navigate to the corresponding page.

Step 2 In the drop-down list on the upper-left corner, select the device type.

Step 3 Check the devices, and click  .

When choosing a battery, it is also necessary to set the start and end times simultaneously, and the time period should not exceed 4 hours.

A dialog displays to indicate the progress of the export.

Step 4 When the export progress reaches "100%", click **Export** to export the logs locally.

--End

12.2 Exporting Logs of Logger1000

Step 1 Click **System > System Maintenance** to navigate to the corresponding page.

Step 2 Click **Log Export** to open the **Log File Type Selection** dialog box.

Step 3 Select the type of logs to you wish to export.

The following types are supported.

- **Commissioning Log**
- **History Data**
- **Scheduling Logs**

Step 4 Click **Confirm** to export the logs locally.

--End

12.3 Exporting Communication Packets

The Logger1000 can capture and export communication packets from various ports. This helps diagnosing issues with connected devices or the Logger1000 itself.

Step 1 Click **System > Message Export** to navigate to the corresponding page.

Step 2 In the drop-down list **Port**, select the port type you wish to capture packets from.

- **Serial Port:** Receive or log packet data from the RS485 port.
- **Network Port:** Receive or log packet data from the network interface.

Step 3 If **Serial Port** is selected, in the drop-down list **Serial Port**, select the COM port for data capture.

Step 4 If **Network Port** is selected, in the drop-down list **Network Port**, select the method of network connection for data capture.

Step 5 In the field **Duration**, set the time period for which you want to log the packets.

Step 6 Click **Start** to start logging the packets.
The packet logging automatically stops at the end of the set time.

Step 7 To manually stop logging the packets, click **Stop**.

Step 8 Click **Export** to export and download the logged data locally.

--End

12.4 Exporting Fault Recorder Data

Step 1 Click **Device > Fault Recorder** to enter the corresponding page.

Step 2 Select the device, and click  to export the data locally.

When choosing a battery, it is also necessary to set the start and end times simultaneously, and the time period should not exceed 4 hours.

Step 3 Extract the contents of the compressed file to a local directory.

Step 4 Open the .txt file using iConfig to review the fault records of the device.

For the installation package and instructions of iConfig, contact SUNGROW customer service.

--End

13 Power Control (PV System)

NOTICE

Power control is available only when the inverter supports active power control, power factor control, and reactive power regulation!
For details, refer to the inverter user manual or consult the local retailer.

13.1 Function Description

The Logger1000 can regulate power output to the connected inverter.

- Supports control of the SUNGROW inverter's power output.
- Supports closed-loop power regulation, with improved accuracy and real-time performance achievable through the use of a meter.
- Supports rapid command transmission channels with millisecond-level processing delays, while ensuring accurate delivery of dispatch commands to all inverters.
- Supports control of power output according to locally preset commands.
- Supports regulation commands via remote communication protocols (IEC104, MODBUS, and TCP), analog inputs (AI), and dry contact inputs (DI).

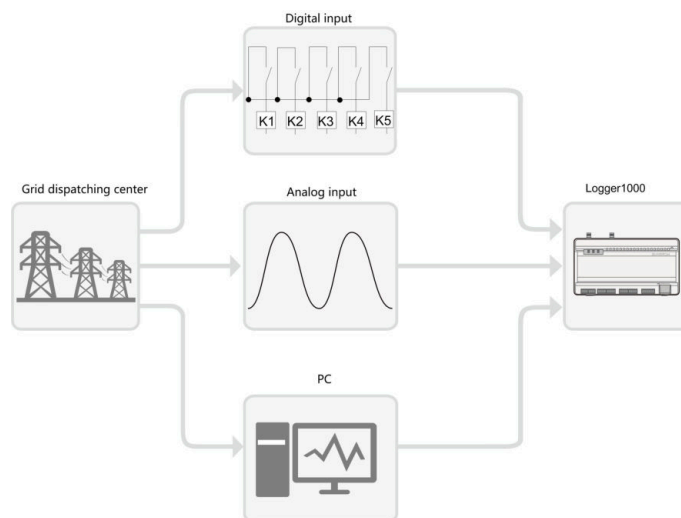

Figure 13-1 System structure for the power control function

13.2 Interface Description

The Logger1000 is equipped with digital control interfaces and analog control interfaces for receiving digital and analog signals sent by the grid dispatching center.

13.2.1 Digital Control Interface

- The analog control interfaces are at the bottom of Logger1000. There are five ports dedicated to digital inputs.
- There are also 4 ports labeled as "AI/DI" that can serve as either analog or digital inputs. To configure the "AI/DI" ports for digital input, a power cable should be connected from the "24V OUT+" port to the "DI" port.

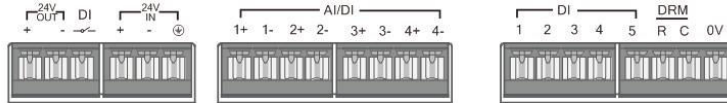

Figure 13-2 Digital Control Interface

Table 13-1 Digital control interface signal definition

Signal	Definition
DI	Enables the switch of AI ports to function as DI ports.
1+, 1-, 2+, 2-, 3+, 3-, 4+, 4-	4 input channels for dry contact signals.
1, 2, 3, 4, 5	5 digital input channels for dry contact signals. The DI5 port is used for connecting the emergency stop device.
DRM	Works together with DI1 to DI4 ports to implement the Demand Response Management (DRM) function.
0V	Grounding point for emergency stop device.

In Germany and some other European countries, grid companies use Ripple Control Receiver to convert grid dispatching signals and transmit them through dry contacts. In this case, the power plant needs to receive the grid dispatching signals through dry contact communication.

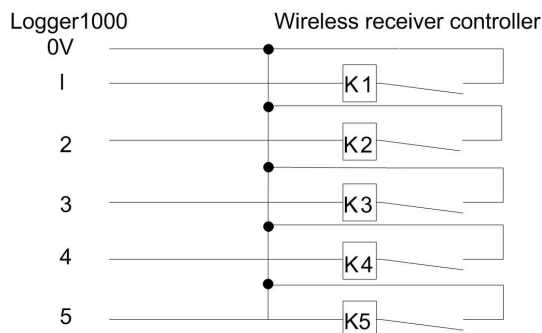

Figure 13-3 Circuitry overview of the connection to a wireless remote controller

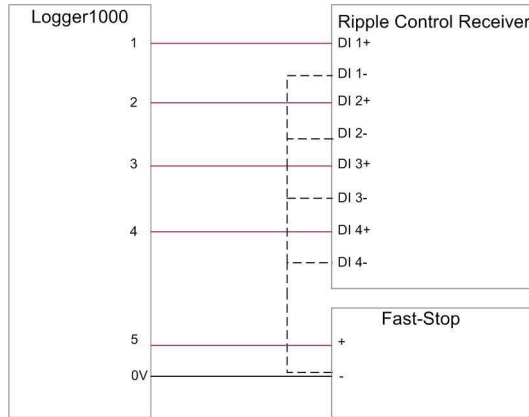

Figure 13-4 Circuitry overview of the connection to active power dry contact

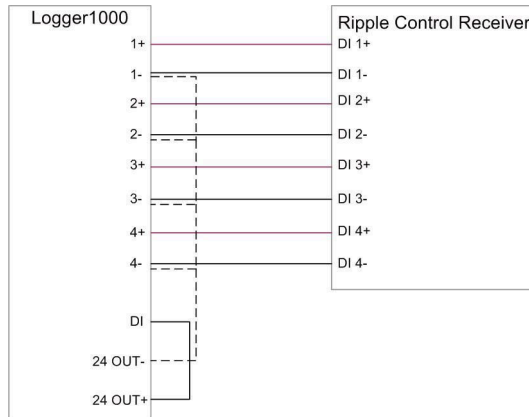

Figure 13-5 Circuitry overview of the connection to reactive power dry contact

13.2.2 Analog Control Interface

- The analog control interfaces are at the bottom of Logger1000, and a total of 4 analog input ports are provided.
- The Logger1000 supports 4 analog inputs, either 4-20mA for current or 0-10V for voltage.

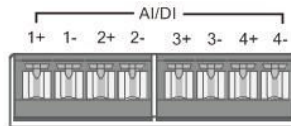

Figure 13-6 Analog Control Interface

Table 13-2 Analog control interface signal definition

Signal	Definition
1+, 1-, 2+, 2-, 3+, 3-, 4+, 4-	4 analog input channels

13.2.3 DRM Control Interface

- The DRM control interface are located at the bottom of Logger1000.
- The DRM interface works together with the DI1 to DI4 ports to implement the DRM function.
- To enable the DRM function, the Logger1000 must connect to a Demand Response Enabling Device (DRED). The connection can be established via wiring terminals or RJ45 connector.

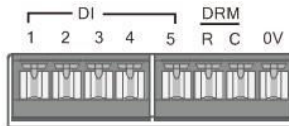

Figure 13-7 DRM Control Interface

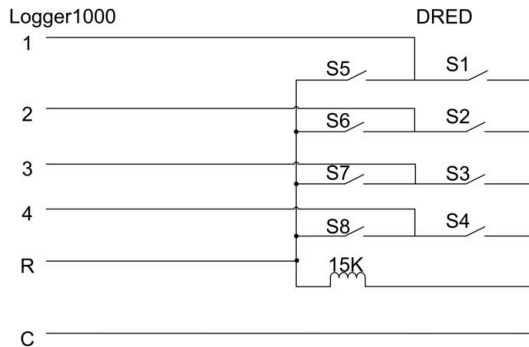

Figure 13-8 Circuitry overview of the connection to the DRED

13.3 Options for Power Control Method

When adjusting active or reactive power, you can select between two control method: open-loop or closed-loop.

Open-Loop Control

Open-loop control does not rely on feedback from the inverter's actual output. Once the Data Logger sends the initial power control command, no further adjustments are made based on the inverter's output. This control method is suitable for scenarios that require quick adjustments.

Closed-Loop control

Closed-loop control depends on feedback from the inverter's actual output. The Data Logger continuously monitors the inverter's output power and compares it to the target power. If any deviation is detected, the Data Logger automatically adjusts the control commands to ensure accuracy and stability in output power. This control method is ideal for scenarios that require precise power adjustments.

To ensure accurate data feedback, closed-loop control requires connecting an smart energy meter or a box transformer with a control device to the Data Logger.

13.4 Selecting Power Control Mode

Both active power limitation and reactive power adjustment support various control methods. You can select based on the scale and needs of your power station.

Mode	Description
Remote Power Control	Remotely control the photovoltaic power generation. Recommended for scenarios requiring power adjustment through PPC (Power Plant Controller) or AGC (Automatic Generation Controller).
Local Power Control	Directly control the inverter's photovoltaic power via the Data Logger. This method is suitable for distributed power stations and zero-feed-in scenarios. Recommended when the power station is in a commissioning phase.
Analog Input	Use digital signals from the Data Logger's AI port (e.g., current or voltage) to adjust inverter power.
Digital Input	Use digital signals from the Data Logger's DI port, typically for responding to dry contact signals.
DRM Mode	Demand Response Management (DRM) is a method for controlling power consumption that adjusts the load in response to signals from the power grid.
Country Mode	Suitable for meeting specific national or regional grid requirements.
Disable Dispatching	Select this option when the power adjustment has started and the inverter needs to maintain its current state.
Disable Derating	Recommended for scenarios where the inverter needs to maintain maximum power output. For example, during peak energy demand periods, this option ensures active power output is not reduced due to power adjustment. Only supports active power control.
Disable Output	Recommended for scenarios where the inverter needs to stop reactive power output. Only supports reactive power control.

Prerequisite

- The web UI has switched to the data acquisition scenario.

Step 1 Click **Power Control** in the navigation bar, from the expanded menu options, select **Active Power** or **Reactive Power**.

Step 2 On the page **Active Power** or **Reactive Power**, in the drop-down list **Active Control Mode** or **Reactive Control Mode**, select the desired power control method.

--End

13.5 Settings for Active Power Control

Prerequisite

- The web UI has switched to the data acquisition scenario. See [7.6 Selecting Usage Scenario of Web UI](#).

Click **Power Control > Active Power** to navigate to the corresponding page.

13.5.1 Remotely Regulating Active Power

Select the monitoring backend that uses the IEC104 or MODBUS TCP protocol as the source of dispatch commands.

Once the remote dispatch configuration is complete, users can send dispatch commands through the monitoring backend.

13.5.1.1 Open-Loop Control

Prerequisite

- The **Active Control Mode** is currently set to **Remote Power Control**. Refer to [13.4 Selecting Power Control Mode](#).

Step 1 In the drop-down list **Control Method**, select **Open-loop Control**.

Step 2 In the field **Query Recovery Time**, specify the time to pause data interaction between the Logger1000 and the inverter.

When power adjustment starts, the Logger1000 temporarily stops regular data reading to prioritize adjusting the inverter's power output for quick and accurate control.

For example, if **Query Recovery Time** is set to "60," the Logger1000 will not collect data from the inverter for 60 seconds after the power adjustment command is received. This might cause a delay in viewing device data via the Web UI or cloud platform during this period.

Step 3 In the field **Frame Delay**, specify the frame interval for the Logger1000 to read inverter data.

Step 4 Click **Save**.

--End

Once the configuration is complete, you can send further power control commands through the backend.

13.5.1.2 Closed-Loop Control

Prerequisite

- The current **Active Control Mode** is set to **Remote Power Control**. Refer to [13.4 Selecting Power Control Mode](#).
- A gateway meter or a box transformer with monitoring and control devices is connected.

Step 1 In the drop-down list **Control Method**, select **Closed-loop Control**.

Step 2 In the drop-down list **Select energy meter/transformer**, select the meter or transformer for power regulation.

Step 3 In the drop-down list **Control Cycle**, specify the interval at which the Logger1000 sends dispatch commands to the inverter.

Step 4 In the field **Error Limit**, specify the allowable error range for the ratio between the difference in actual active power and the target value, relative to the rated power.

If the ratio is within the error range, the power adjustment is considered to have reached the target value. You should adjust this parameter in real-time based on the inverter's output power.

Step 5 In the field **Adjustment Ratio**, set the ratio between the inverter's output power and the target value.

If the adjustment result does not reach the set target value, the Logger1000 will adjust according to the set adjustment ratio to achieve the target value. You should adjust this parameter in real-time based on the inverter's output power.

Step 6 Click **Save**.

--End

Once the configuration is complete, you can send further power control commands through the backend.

13.5.2 Locally Regulating Active Power

Configure the parameters for local active power control.

13.5.2.1 Open-Loop Control

Prerequisite

- The **Active Control Mode** is currently set to **Local Power Control**. Refer to [13.4 Selecting Power Control Mode](#).

Step 1 In the drop-down list **Control Method**, select **Open-loop Control**.

Step 2 In the drop-down list **Control Cycle**, specify the interval at which the Logger1000 sends dispatch commands to the inverter.

Step 3 In the drop-down list **Instruction Type**, select the designated unit for power regulation.

- **kW**: Adjusts the power by setting the total rated power of the inverter array. Recommended for scenarios where precise control of the inverter's output power is required, such as when a power station needs to comply with grid capacity limits.

- **%**: Adjusts power based on a percentage of the inverter's maximum rated power. Recommended for scenarios where the output needs to be adjusted according to the inverter's capacity.

Step 4 Click **Save**.

--End

After configuration, specify the time and target values for local power control. Refer to [13.5.2.3 Configuring Adjustment Time and Target Values](#).

13.5.2.2 Closed-Loop Control

Prerequisite

- The current **Active Control Mode** is set to **Local Power Control**. For details, see [13.4 Selecting Power Control Mode](#).
- For closed-loop control, a gateway meter for power control must be connected.

Step 1 In the drop-down list **Control Method**, select **Closed-loop Control**.

Step 2 In the drop-down list **Select energy meter/transformer**, select the meter or transformer for power regulation.

Step 3 When the communication with the meter is interrupted, configure the relevant parameters of the Logger1000.

- a. In the field **Power Limit in Case of Meter Communication Anomaly**, specify the target value as a percentage to be issued by the Logger1000 when there is a communication failure with the meter.

When **Power Limit in Case of Meter Communication Anomaly** is set to "0%", the Logger1000 will send a shutdown command to the inverter after confirming the communication failure with the meter.

- b. When the inverters are shut, in the drop-down list **Start After Communication Recovery**, select whether the Logger1000 should send a power-on command to the inverters when communication with the meter resumes.

- **Enable**: When the communication resumes, the inverter will restart.
- **Disable**: When the communication resumes, the inverter will remain shut down.

- c. In the field **Start Delay After Communication Recovery**, specify the waiting time for the Logger1000 to send a power-on command to the inverter after communication is restored.

Step 4 If zero power feed-in is required, in the drop-down list **Wiring Mode**, select the connection mode of the Logger1000 based on the actual situation.

- **Direct Connection**: The Logger1000 establishes direct connections with all string or central inverters.
- **Cascading**: Multiple Logger1000 devices are interconnected in a cascading manner, with this particular Logger1000 as the master unit within the network.

Step 5 In the drop-down list **Feed-in Stop**, select whether the Logger1000 should send a shutdown command to the inverter when grid power feed-in is detected.

- **Enable:** The inverter will shut down when feed-in power is detected by the meter. Select this option when zero power feed-in is required.

After the inverter shuts down, if the meter detects that the power draw exceeds the configured power-on draw threshold (3%–10%) of the system's rated power, the Logger1000 will send a power-on command to the inverter.

- **Disable:** The inverter will remain on even when feed-in power is detected by the meter.

Step 6 In the drop-down list **Feed-in Control Mode**, select the grid control mode according to the type of data the meter collects.

- **Total Active Power Control:** The meter collects three-phase data on the grid side as the feedback value for regulation.
- **Split Phase Active Power Control:** The meter collects single-phase data as the feedback value for regulation.

Step 7 In the field **Energy Meter Response Time**, based on the model of the connected meter, adjust the meter response time, to improve grid feed-in speed and precision.

Step 8 In the field **Over-scaling**, enter the desired value for over-scaling.

Based on the initial power limit target, Logger1000 will adjust the inverter's output once to ensure it stays below the set limit, without the need for repeated adjustments. It is recommended to use this parameter in scenarios that require stringent power control, such as anti-backflow or achieving zero power feed-in.

Step 9 In the drop-down list **Inverter communication interruption configuration**, select the communication interruption protection mode for the inverter.

- **Close:** When the inverter-logger communication is interrupted, the communication interruption protection is not triggered, and the inverter will operate according to the original logic, not taking protective actions.
- **Preset mode:** When the inverter-logger communication is interrupted, the communication interruption protection is triggered in the inverter, which takes protective actions (for example, power reduction or shutdown).

This feature is available on LOGGER-SV500.001.00.P014 or higher.

Step 10 When **Preset mode** is selected, input values in the following fields.

- Communication interruption trigger delay (s):** Enables you to set the interruption duration threshold, within the range of 1 – 36000s. If communication interruption is longer than that, it is seen as a fault that triggers protection.
- Preset power limit ratio (%):** When the communication fault is confirmed, the inverter will automatically limit its output power to this preset ratio to ensure safe operation.

This feature is available on LOGGER-SV500.001.00.P014 or higher.

Step 11 In the drop-down list **Control Cycle**, specify the interval at which the Logger1000 sends dispatch commands to the inverter.

Step 12 In the drop-down list **Instruction Type**, select the designated unit for power regulation.

- **kW**: Adjusts the power by setting the total rated power of the inverter array. Recommended for scenarios where precise control of the inverter's output power is required, such as when a power station needs to comply with grid capacity limits.
- **%**: Adjusts power based on a percentage of the inverter's maximum rated power. Recommended for scenarios where the output needs to be adjusted according to the inverter's capacity.

Step 13 When **kW** is selected, set a reasonable feed-in power value according to local regulations.

Step 14 When **%** is selected, in the drop-down list **Feed-in Limitation Method**, select a basis for limiting the grid-connected power.

- **Nominal Power**: Calculate the value to be sent for power control based on the inverter's rated power.
- **Installed PV Power**: Calculate the value to be sent for power control based on the installed PV capacity. Enter the total installed power of PV modules at the power plant.

Step 15 Click **Save**.

--End

After configuration, specify the time and target values for local power control. For details, see [13.5.2.3 Configuring Adjustment Time and Target Values](#).

13.5.2.3 Configuring Adjustment Time and Target Values

Prerequisite

- The selected power control strategy and related configurations are complete.

The specific time and target values for local power control is presented in a table.

<input type="checkbox"/>	Start Time	Percentage
<input type="checkbox"/>	00:00	
<input type="checkbox"/>		
<input type="checkbox"/>		
<input type="checkbox"/>		
<input type="checkbox"/>		
<input type="checkbox"/>		
<input type="checkbox"/>		
<input type="checkbox"/>		
<input type="checkbox"/>		
<input type="checkbox"/>		
<input type="checkbox"/>		

If no additional combinations of time and target values are set, the Logger1000 will adjust power according to default values throughout the day.

Step 1 Position the cursor in the column **Start Time**, and in the time picker, select the time to deliver the power control command.

Time is precise to the minute. The default power adjustment starts at "00:00" and cannot be changed.

Step 2 Depending on the selected **Instruction Type**, enter the target value for active power in the corresponding column **Fixed Value of Active Power** or **Percentage**.

To meet zero power feed-in or anti-backflow requirements, set the target value to "0", indicating that the inverter will not output any active power to the grid. However, to strictly control feed-in power and handle load fluctuations, it is recommended to set the target value to a negative number. After configuration, the load will draw power from the grid instead, ensuring the inverter does not active power is fed into the grid.

Step 3 To delete a specific adjustment time and target value, check the corresponding box in the first column, and click **Clear Data**.

Step 4 Click **Save**.

--End

13.5.3 Regulating Active Power via Analog Input

Prerequisite

- The **Active Control Mode** is currently set to **Analog Input**. Refer to [13.4 Selecting Power Control Mode](#).
- For closed-loop control, a gateway meter for power control must be connected.
- Certain parameters are only configurable when the IOM424 module is connected.

Step 1 In the drop-down list **Control Method**, select **Open-loop Control** or **Closed-loop Control**.

Step 2 For **Closed-loop Control**, in the drop-down list **Select energy meter/transformer**, select the meter or transformer for power regulation.

Step 3 In the drop-down list **Control Cycle**, specify the interval at which the Logger1000 sends dispatch commands to the inverter.

Step 4 In the drop-down list **AI Port**, select the AI port that accepts the analog input signals.

To configure the AI port parameters, click **AI Configuration** to navigate to the **System > Port Parameter > AI** page. See [8.5 Analog Input \(AI\) Port](#).

Step 5 In the drop-down list **Instruction Type**, select the designated unit for power regulation.

- **kW**: Adjusts the power by setting the total rated power of the inverter array. Recommended for scenarios where precise control of the inverter's output power is required, such as when a power station needs to comply with grid capacity limits.
- **%**: Adjusts power based on a percentage of the inverter's maximum rated power. Recommended for scenarios where the output needs to be adjusted according to the inverter's capacity.

Step 6 Depending on the **Instruction Type**, in the field **Min** and **Max**, set the target value range for power control.

- When **Instruction Type** is set to %, the range of **Min** and **Max** is 0 to 100%.
- **Instruction Type** When selecting **kW**, the range of **Min** and **Max** is 0.0 kW to 999999.9 kW.

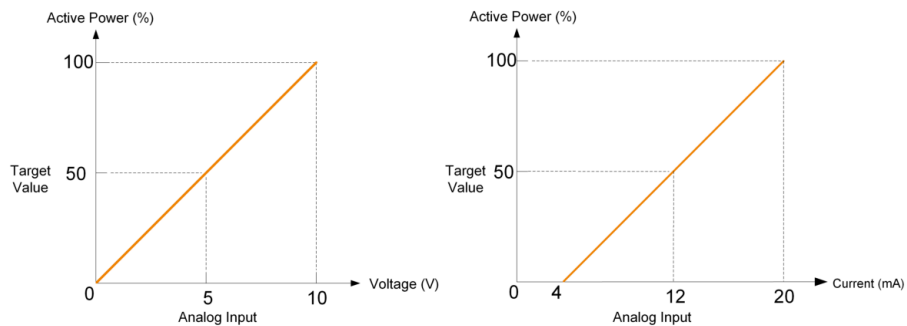

Figure 13-9 Example of the relationship between analog input values and target values

Step 7 Depending on **Instruction Type**, in the field **Step**, set the minimum difference value between two consecutive power control commands.

Step 8 When **Open-loop Control** is selected, configure the following parameters.

- In the **Sampling Value Less Than Lower Limit Power Value** field, enter the power limit ratio to be sent when the sampled value from the AI channel is below the lower limit.
- In the drop-down list **Sampling Value Less Than Lower Limit Associated DO**, select the associated DO port.
 If the sampled value from the AI channel falls below the lower limit, this DO port will be activated to perform the specified action.
- In the field **Sampling Value Less Than Lower Limit Fault Recovery Time**, set the time required for the DO port to restore to the initial state when the sampled value from the AI channel falls below the lower limit.
- In the **Sampling Value Greater Than Upper Limit Power Value** field, set the power limit ratio to be sent when the sampled value from the AI channel exceeds the upper limit.
- In the drop-down list **Sampling Value Greater Than Upper Limit Associated DO**, select the associated DO port.
 If the sampled value from the AI channel exceeds the upper limit, this DO port will be activated to perform the specified action.
- In the field **Sampling Value Greater Than Upper Limit Fault Recovery Time**, set the time required for the DO port to restore to the initial state when the sampled value from the AI channel exceeds the upper limit.

Step 9 Click **Save**.

--End

13.5.4 Regulating Active Power via Digital Input

Prerequisite

- The **Active Control Mode** is currently set to **Digital Input**. Refer to [13.4 Selecting Power Control Mode](#).
- For closed-loop control, a gateway meter for power control must be connected.

Step 1 In the drop-down list **Control Method**, select **Open-loop Control** or **Closed-loop Control**.

Step 2 For **Closed-loop Control**, in the drop-down list **Select energy meter/transformer**, select the meter or transformer for power regulation.

Step 3 In the drop-down list **Control Cycle**, specify the interval at which the Logger1000 sends dispatch commands to the inverter.

Step 4 In the drop-down list **Instruction Type**, select the designated unit for power regulation.

- **kW**: Adjusts the power by setting the total rated power of the inverter array. Recommended for scenarios where precise control of the inverter's output power is required, such as when a power station needs to comply with grid capacity limits.
- **%**: Adjusts power based on a percentage of the inverter's maximum rated power. Recommended for scenarios where the output needs to be adjusted according to the inverter's capacity.

Step 5 When **Closed-loop Control** is selected, and the unit for target value is set to **%**, in the drop-down list **Feed-in Limitation Method**, specify a reference for limiting the grid-connected power.

- **Nominal Power**: Calculate the value to be sent for power control based on the inverter's rated power.
- **Installed PV Power**: Calculate the value to be sent for power control based on the installed PV capacity. Enter the total installed power of PV modules at the power plant.

Step 6 In the table at the bottom of the page, set the target values for power control corresponding to the digital input signals.

- Based on the dry contact signals received by the DI ports, check the corresponding DI port.
- Depending on the **Instruction Type**, enter a fixed value or a percentage for active power control.

To delete the DI signal configuration, select the checkbox in the first column of the row, and click **Clear Data**.

Step 7 Click **Save**.

--End

13.5.5 Regulating Power via DRM

Prerequisite

- The **Active Control Mode** is currently set to **DRM Mode**. See [13.4 Selecting Power Control Mode](#).

Step 1 When selecting DRM mode, check the box **Whether it coexists with other active control modes** according to actual requirements.

Step 2 Click **Save**.

--End

13.5.6 Regulating Active Power via Country Mode

Implement power regulations according to the commands issued by the national grid dispatching center.

13.5.6.1 Korea

Step 1 In the drop-down list **Country**, select **Korea**.

Step 2 In the drop-down list **PPC Type**, select the power plant controller DER-AVM.

Step 3 In the field **Forwarding Modbus ID**, enter the Modbus forwarding address (Range: 1~10).

Step 4 Click **Save**.

--End

13.5.6.2 Japan

Step 1 In the drop-down list **Country**, select **Japan**.

Step 2 In the drop-down list **Control Method**, select **Open-loop Control** or **Closed-loop Control**.

Step 3 When **Closed-loop Control** is selected, click **Closed-loop Control Parameters** to modify the closed-loop control related parameters.

The following parameters can be configured:

- **Select Meter**
- **Wiring Mode**
- **Feed-in Control Mode**
- **Energy Meter Response Time**
- **Over-scaling**
- **Active Power Change Rate**: The rate of change of active power over time. Used to control the acceleration and deceleration of active power to prevent sudden power changes from impacting the grid.
- **Control Cycle**

Step 4 In the drop-down list **Scheduling Mode**, select the required power company for the power plant.

The Logger1000 will connect to the dispatch server designated by the power company.

Step 5 In the drop-down list **Obtaining Schedule**, select the method to retrieve the dispatch schedule.

- **Remote Download**: Download the schedule through the server address. The ID of the power plant must be entered.
- **Local Import**: Manually upload the schedule.

Step 6 In the drop-down list **Parameter Type**, select the type of the parameters.

- **Plant Parameter**: Both **Plant Information** and **PV Module Capacity** must be set.

- **Device Parameter** : Click **Detailed Device Parameter** to view and set the device's detailed information.

Step 7 In the drop-down list **Time Calibration**, select the number of minutes to adjust the current time.

Select a positive value to advance the time, or select a negative value to set the time back.

The field **Time Validity** displays the time calibration result.

If it displays **Invalid**, the Logger1000 sends a shutdown command to the connected inverters, until the time is correctly calibrated or synchronized.

The time calibration may not be valid for the following reasons:

- The Logger1000 system time is earlier than the calibrated time
- The Logger1000 system time is earlier than the time synchronized via NTP

Step 8 Click **Save**.

--End

13.5.7 Disabling Active Power Control

If the Logger1000 has already limited the inverter's active power and you need the inverter to maintain its current state, you can disable active power control.

Step 1 On the **Active Power** page, set **Active Control Mode** to **Disable Dispatching**.

Step 2 Click **Save**.

--End

Once the settings are completed, the inverter will continue to operate with the current active power adjustment limit.

13.5.8 Prohibiting the Inverter from Reducing Power Output

Step 1 On the **Active Power** page, set **Active Control Mode** to **Disable Derating**.

Step 2 Click **Save**.

--End

Once the settings are completed, the Logger1000 will stop limiting active power, and the inverter will operate at full load, maintaining an output power level of "100%".

13.6 Settings for Reactive Power Control

Prerequisite

- The web UI has switched to the data acquisition scenario.

Click **Power Control > Reactive Power** to navigate to the corresponding page.

13.6.1 Remotely Regulating Reactive Power

Prerequisite

- The **Reactive Control Mode** is currently set to **Remote Power Control**. Refer to [13.4 Selecting Power Control Mode](#).

- For closed-loop control, a gateway meter or a box transformer with monitoring and control devices must be connected.

Step 1 In the drop-down list **Control Method**, select **Open-loop Control** or **Closed-loop Control**.

Step 2 When **Open-loop Control** is selected, refer to the remote active power control and configure the corresponding parameters. Refer to [13.5.1.1 Open-Loop Control](#).

Step 3 When **Closed-loop Control** is selected, refer to the remote active power control and configure the corresponding parameters. Refer to [13.5.1.2 Closed-Loop Control](#).

Step 4 When **Closed-loop Control** is selected, in the drop-down list **Reactive Power Direction**, select whether the reactive power output direction recorded by the meter or transformer matches the inverter.

By default, the SUNGROW inverter outputs inductive reactive power (positive) when the grid needs to increase voltage, and capacitive reactive power (negative) when it needs to decrease voltage.

- **Forward Direction:** The reactive power direction recorded at the grid connection point matches the inverter's reactive power direction.
- **Direction Reverse:** The reactive power direction recorded at the grid connection point is opposite to the inverter's reactive power direction.

Step 5 Click **Save**.

--End

13.6.2 Locally Regulating Reactive Power

Configure the parameters for local reactive power control.

Prerequisite

- The **Reactive Control Mode** is currently set to **Local Power Control**. Refer to [13.4 Selecting Power Control Mode](#).
- For closed-loop control, a gateway meter for power control must be connected.

Step 1 In the drop-down list **Control Method**, select **Open-loop Control** or **Closed-loop Control**.

Step 2 In the drop-down list **Instruction Type**, select the designated unit for power regulation.

- **PF:** Adjusts power based on the power factor. Recommended for scenarios where the inverter needs to maintain a specific power factor level.
- **%:** Adjusts power based on a percentage of the inverter's maximum rated power. Recommended for scenarios where the output needs to be adjusted according to the inverter's capacity.

Step 3 When **Open-loop Control** is selected, refer to the local active power control and configure the corresponding parameters. Refer to [13.5.2.1 Open-Loop Control](#).

Step 4 When **Closed-loop Control** is selected, refer to the local active power control and configure the corresponding parameters. Refer to [13.5.2.2 Closed-Loop Control](#).

Step 5 When **Closed-loop Control** is selected, in the field **Line Reactive Power Compensation**, estimate and set the reactive power loss in the line.

Step 6 Refer to local active power control and add dispatch time and target values. Refer to [13.5.2.3 Configuring Adjustment Time and Target Values](#).

--End

13.6.3 Regulating Reactive Power via Analog Input

Prerequisite

- The **Reactive Control Mode** is currently set to **Analog Input**. Refer to [13.4 Selecting Power Control Mode](#).
- For closed-loop control, a gateway meter for power control must be connected.

Step 1 In the drop-down list **Control Method**, select **Open-loop Control** or **Closed-loop Control**.

Step 2 When **Closed-loop Control** is selected, configure the following parameters.

- a. In the drop-down list **Select energy meter/transformer**, select the meter or transformer for power regulation.
- b. In the drop-down list **Control Cycle**, specify the interval at which the Logger1000 sends dispatch commands to the inverter.

Step 3 In the drop-down list **AI Port**, select the AI port that accepts the analog input signals.

To configure the AI port parameters, click **AI Configuration** to navigate to the **System > Port Parameter > AI** page. See [8.5 Analog Input \(AI\) Port](#).

Step 4 In the drop-down list **Instruction Type**, select the designated unit for power regulation.

- **PF**: Adjusts power based on the power factor. Recommended for scenarios where the inverter needs to maintain a specific power factor level.
- **%**: Adjusts power based on a percentage of the inverter's maximum rated power. Recommended for scenarios where the output needs to be adjusted according to the inverter's capacity.

Step 5 Depending on the **Instruction Type**, in the field **Min** and **Max**, set the target value range for power control.

- **%** : The range of **Min** and **Max** is -100% to 100%.
- **PF** : The range of **Min** and **Max** is -1~-0.8 or 0.8 to 1.

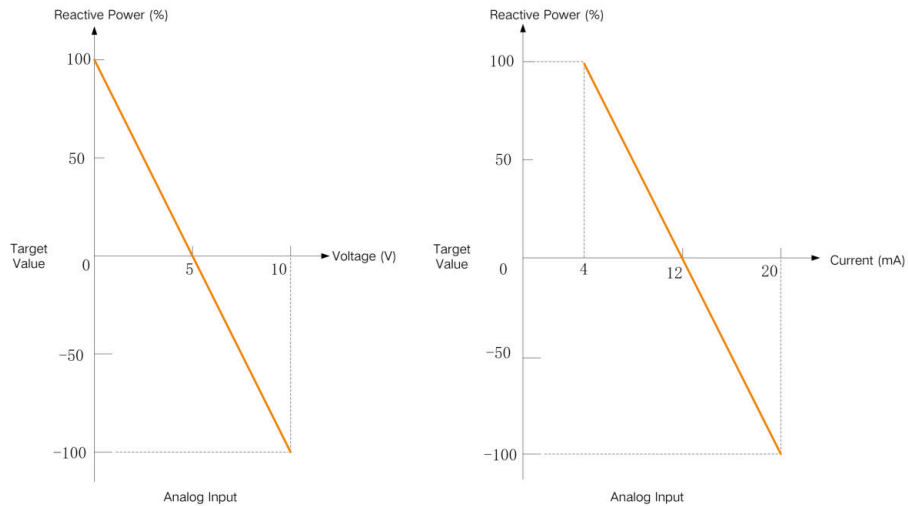

Figure 13-10 Example of the relationship between analog input values and target values

Step 6 Depending on **Instruction Type**, in the field **Step**, set the minimum difference value between two consecutive power control commands.

Step 7 For with **Instruction Type** to **PF**, in the field **Hysteresis Range**, specify a deadband range that maintains the PF at ± 1 to avoid frequent sudden changes in power factor.

Step 8 Click **Save**.

--End

13.6.4 Regulating Reactive Power via Digital Input

Prerequisite

- The **Reactive Control Mode** is currently set to **Digital Input**. Refer to [13.4 Selecting Power Control Mode](#).
- For closed-loop control, a gateway meter for power control must be connected.

Step 1 In the drop-down list **Control Method**, select **Open-loop Control** or **Closed-loop Control**.

Step 2 When **Closed-loop Control** is selected, configure the following parameters.

- In the drop-down list **Select energy meter/transformer**, select the meter or transformer for power regulation.
- In the drop-down list **Control Cycle**, specify the interval at which the Logger1000 sends dispatch commands to the inverter.

Step 3 In the drop-down list **Instruction Type**, select the designated unit for power regulation.

- **PF**: Adjusts power based on the power factor. Recommended for scenarios where the inverter needs to maintain a specific power factor level.
- **%**: Adjusts power based on a percentage of the inverter's maximum rated power. Recommended for scenarios where the output needs to be adjusted according to the inverter's capacity.

- Step 4** In the table at the bottom of the page, set the target values for power control corresponding to the digital input signals.
- Based on the dry contact signals received by the DI ports, check the corresponding DI port.
 - Depending on the **Instruction Type**, enter a percentage or a power factor for reactive power control.

To delete the DI signal configuration, select the checkbox in the first column of the row, and click **Clear Data**.

Step 5 Click **Save**.

--End

13.6.5 Regulating Reactive Power via Country Mode

Implement power regulations according to the commands issued by the national grid dispatching center.

Prerequisite

- The **Reactive Control Mode** is currently set to **Country Mode**. See [13.4 Selecting Power Control Mode](#).

Step 1 In the drop-down list **Country**, select the country where inverters are located.

Step 2 When the country is set to **Korea**, configure the following parameters.

- In the drop-down list **PPC Type**, select the power plant controller DER-AVM.
- In the field **Forwarding Modbus ID**, enter the Modbus forwarding address (Range: 1~10).
- In the drop-down list **Instruction Type**, select the type of dispatch commands.

Step 3 Click **Save**.

--End

13.6.6 Disabling Reactive Power Control

Disable the Logger1000 from controlling reactive power to the inverter.

Step 1 On the **Reactive Power** page, set **Reactive Control Mode** to **Disable Dispatching**.

Step 2 Click **Save**.

--End

Once the settings are completed, the inverter will continue to operate with the current reactive power adjustment limit.

13.6.7 Disabling Reactive Power Output

In certain situations, such as when the grid company does not require voltage regulation at the grid-connection point and no reactive power compensation is needed, you can set the inverter to stop reactive power output. This helps maintain overall grid stability and prevents voltage fluctuations caused by reactive power adjustment.

Step 1 On the **Reactive Power** page, set **Reactive Control Mode** to **Disable Output**.

Step 2 Click **Save**.

--End

Once the settings are completed, the inverter's reactive power output will return to "0%".

13.7 Setting Emergency Stop

If the emergency stop switch is activated, the Logger1000 will initiate a batch power-off operation on the inverters.

Prerequisite

- The Logger1000 is connected to the emergency stop device. See [5.11 Connecting to the Emergency Stop Device](#).

Step 1 Click **Power Control > Emergency Button** to navigate to the corresponding page.

Step 2 Set **Emergency Button** to **Enable**.

Step 3 Set Inverter Status During Emergency Stop Recovery to **Boot**.

After resetting the emergency stop switch, the inverters will automatically power on.

Step 4 Click **Save** to apply the changes.

--End

If the inverters remain in standby mode after resetting the emergency stop switch, manually start the inverters through **Device Monitoring > Device Instruction**. If there is any problem, contact SUNGROW.

14 Power Control (Energy Storage System)

In the energy management scenario, the options for power control may vary depending on the firmware version of the Logger1000. Always refer to the actual interface for up-to-date and precise information.

14.1 Settings for Active Power Control

Prerequisite

- The web UI has switched to the energy management scenario. See [7.6 Selecting Usage Scenario of Web UI](#).

14.1.1 Power Regulation using Digital Inputs

The DI power control support Demand Response Management (DRM) and Ripple Control systems through dry contact communication. If an emergency stop device is connected, an emergency stop function can be implemented for additional safety and control.

The following options are supported:

- **DRM**
- **Ripple Control**

To disable power control using DI, in the drop-down list **DI Control Method**, select **Close**.

14.1.1.1 Controlling Power via DRM

Demand Response Management (DRM) is a method for controlling power consumption that adjusts the load in response to signals from the power grid.

Step 1 Click **Power Control > Active Power** to navigate to the corresponding page.

The **DI Power Regulation** tab page displays.

Step 2 In the drop-down list **DI Control Method**, select **DRM**.

Step 3 Click **Save**.

--End

14.1.1.2 Controlling Power via Ripple Control

The Ripple Control mode adjusts power according to the grid's control signal received through dry contacts, suitable for Germany and other parts of Europe.

When Ripple Control is activated, dispatch signals are conveyed by the power grid company through digital input ports. There are 16 available DI signal configurations, each associated with a specific power ratio. You must configure these DI ports on the Web UI

according to the requirements of the utility company to correctly receive and respond to these signals.

Table 14-1 Signal states of DI ports

Icon	Description
<input type="checkbox"/>	The digital signal source is in an open state.
<input checked="" type="checkbox"/>	The digital signal source is in a closed state.

Each DI signal configuration must be unique.

Step 1 Click **Power Control > Active Power** to navigate to the corresponding page.

The **DI Power Regulation** tab page displays.

Step 2 In the drop-down list **DI Control Method**, select **Ripple Control**.

Step 3 In the drop-down list **Inverter Output Power Limit Ratio Calculation Basis**, select the reference for limiting the inverter's output power.

- **Nominal Power:** Calculate the value to be sent for power control based on the inverter's rated power.
- **Installed PV Power:** Calculate the value to be sent for power control based on the installed PV capacity. Enter the total installed power of PV modules at the power plant.

Step 4 Check the digital signal ports and specify the desired power ratio (range: 0-100%).

A default DI signal configuration appears below for initial setup.

Step 5 Click  to add additional DI signal configurations.

Step 6 Click **Save**.

--End

14.1.1.3 Setting Emergency Stop

When the emergency stop function is enabled, you can initiate an emergency shutdown of the inverter.

Emergency stop modes

Mode	Description
Close	Do not enable the emergency stop.
Stop Inverter	When the emergency stop is activated, the inverters will cease feeding electricity into the grid and will not accept electricity from the grid. The inverter enters emergency stop state.

Mode	Description
Stop Inverter and Trip Battery	<p>When the emergency stop is, the inverters will cease feeding electricity into the grid, and the batteries will also stop electrical interaction with the inverters and the grid. This means the batteries will neither charge nor discharge. The inverter enters emergency stop state, and the battery enters a tripped state.</p>

Prerequisite

- The Logger1000 is connected to the emergency stop device. See [5.11 Connecting to the Emergency Stop Device](#).

Step 1 Click **Power Control > Active Power** to navigate to the corresponding page. The **DI Power Regulation** tab page displays.

Step 2 In the drop-down list **Emergency Stop Function**, select whether to enable the emergency stop function and the preferred emergency stop mode.

If the batteries enter standby mode due to an emergency stop, they need to be manually restarted to resume normal operation.

Step 3 If **Stop Inverter** or **Stop Inverter and Trip Battery** is selected, in the drop-down list **Emergency Stop Status**, specify which state of the digital signal source from the DI5 port will initiate the emergency stop.

- **Disconnect:** The emergency stop is triggered when the emergency stop switch is in an open state.
- **Closed:** The emergency stop is triggered when the emergency stop switch is in a closed state.

Step 4 Click **Save**.

--End

14.1.2 Local Power Control

If Local power control is selected in Active power control, the system directly accepts the active power regulation commands issued by Logger1000. O&M personnel can configure parameters related to feed-in power to achieve zero export. If a communication fault occurs between the Logger1000 and the PoC meter, you can configure the relevant parameters to ensure effective management and maintenance of the inverter's power output.

The **Feed-in power limit** can be set on the **Power Control > Grid-connection Power Regulation** or **Power Control > Active Power** page. In practical applications, if the parameter is configured on both pages, the lower value prevails.

Prerequisite

- If Closed-loop control is selected, a PoC meter must be connected for power regulation.

Step 1 Choose **Power Control > Active Power**.

By default, the **DI Power Regulation** tab is displayed on the Web.

Step 2 Click the **Local Power Control** tab.

Step 3 Select **Closed-loop Control** from the **Local Power Control Method** drop-down list.

Step 4 When the communication with the meter is interrupted, configure the relevant parameters of the Logger1000.

- a. In the field **Power Limit in Case of Meter Communication Anomaly**, specify the target value as a percentage to be issued by the Logger1000 when there is a communication failure with the meter.

When **Power Limit in Case of Meter Communication Anomaly** is set to "0%", the Logger1000 will send a shutdown command to the inverter after confirming the communication failure with the meter.

- b. When the inverters are shut, in the drop-down list **Start After Communication Recovery**, select whether the Logger1000 should send a power-on command to the inverters when communication with the meter resumes.
 - **Enable**: When the communication resumes, the inverter will restart.
 - **Disable**: When the communication resumes, the inverter will remain shut down.
- c. In the field **Start Delay After Communication Recovery**, specify the waiting time for the Logger1000 to send a power-on command to the inverter after communication is restored.

Step 5 In the drop-down list **Feed-in Stop**, select whether the Logger1000 should send a shutdown command to the inverter when grid power feed-in is detected.

- **Enable**: The inverter will shut down when feed-in power is detected by the meter. Select this option when zero power feed-in is required.

After the inverter shuts down, if the meter detects that the power draw exceeds 10% of the system's rated power, the Logger1000 will send a power-on command to the inverter.

- **Disable**: The inverter will remain on even when feed-in power is detected by the meter.

Step 6 In the field **Over-scaling**, enter the desired value for over-scaling.

Based on the initial power limit target, Logger1000 will adjust the inverter's output once to ensure it stays below the set limit, without the need for repeated adjustments. It is recommended to use this parameter in scenarios that require stringent power control, such as anti-backflow or achieving zero power feed-in.

Step 7 Click **Save**.

--End

14.1.3 Remote Power Control

When controlling active power remotely, the system receives adjustment commands through TCP services such as Modbus TCP.

Using remote control to adjust active power automatically deactivates any locally selected energy management modes. Adjustments are made through commands from the remote backend.

Step 1 Click **Power Control > Active Power** to navigate to the corresponding page.

The **DI Power Regulation** tab page displays.

Step 2 Select tab **Remote Power Control**.

Step 3 In the drop-down list **Remote Power Control Method**, select **Open-loop Control**.

Step 4 Click **Save**.

--End

14.2 Settings for Reactive Power Control

If reactive power is controlled locally, the system directly accepts adjustment commands from the Logger1000. You can configure the power factor for the grid-connection point. Once configured, the inverter adjusts its reactive output based on the meter's data to maintain grid stability and efficiency.

It is currently not supported to control reactive power remotely via the IEC 104 protocol.

Prerequisite

- The web UI has switched to the energy management scenario, see [7.6 Selecting Usage Scenario of Web UI](#).

Step 1 Click **Power Control > Reactive Power** to navigate to the corresponding page.

The **Local Power Control** tab page displays.

Step 2 In the drop-down list **Local Power Control Method**, select **Closed-loop Control**.

Step 3 In the drop-down list **Instruction Type**, select the designated unit for power regulation. The default is **PF** (power factor).

Step 4 In the field **Line Reactive Power Compensation**, estimate and set the reactive power loss in the line.

Step 5 In the drop-down list **Control Cycle**, specify the interval at which the Logger1000 sends dispatch commands to the inverter.

Step 6 In the field **Target Power Factor**, enter the target power factor for adjustment based on the actual energy usage at the power station. Data range: -1 to -0.8 or 0.8 to 1.

Step 7 Click **Save**.

--End

15 Energy Management

In the energy management scenario, you can control the energy distribution of the energy storage system by limiting grid-connected power, selecting a working mode, and adjusting active or reactive power.

15.1 Requirements

15.1.1 Adding a Meter

Prerequisite

- The web UI has switched to the energy management scenario. See [7.6 Selecting Usage Scenario of Web UI](#).
- The meter is connected to the Logger1000.

Step 1 Navigate to the page **Device > Device List**, and click **Add Device** to open the **Add Device** dialog box.

Step 2 In the drop-down list **Device Type**, select **Meter**.

Step 3 Select the type of the meter.

- a. In the drop-down list **Access Type**, select the type of the meter according to its purpose and actual installation location: **Electricity Meter** or **Gateway Meter**.

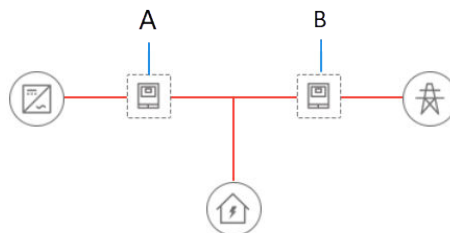

Position	Type	Description
A	Electricity meter	Used to monitor power consumption on the inverter side.
B	Gateway meter	Used to monitor power consumption on the grid side.

- b. If **Electricity Meter** is selected, in the drop-down list **Meter Usage**, select the purpose of the meter based on the actual use scenario.

- **Fcas Sampling:** This meter is used for grid-data sampling for Frequency Control Ancillary Services (FCAS). Select this option for scenarios involving integration with the FCAS system in Australia. After configuration, the FCAS system regulates the inverter's power generation to maintain the stability of the energy storage system.
 - **Third-party Power System Sampling:** This meter is used for monitoring energy consumption and production in third-party generation systems. Recommended for scenarios that involve connecting to third-party inverters.
- c. If **Gateway Meter** is selected, in the drop-down list **Meter Usage**, select the purpose of the meter based on the actual use scenario.
- **Grid-connected Power Control:** This meter is used for monitoring and controlling the power station's output power. By default, the system regulates power based on the feedback values recorded by the meter.
 - **Grid-connected Power Monitoring:** This meter is used for collecting data from associated devices and syncs it to the cloud. Recommended for verifying data at the grid-connection point.

Step 4 In the drop-down list **Port**, select the port that the meter is connected to.

Step 5 If **NET** is selected, set the network parameters for the meter.

- a. In the drop-down list **Protocol Type**, select the communication method between the meter and the Logger1000. The default is **MODBUS-TCP**.
- b. In the fields **Peer IP Address** and **Peer Port**, enter the IP address and port number of the meter, respectively.

Step 6 In the drop-down list **Device Model**, select the model of the meter.

If the model is not in the drop-down list, select **Others**, and import the meter information either by setting measuring points or by uploading a configuration file. See [10.2 Adding a Third-Party Device](#).

Please ensure that the selected meter model matches the actual meter installed.

Step 7 Enter the address of the meter based on the selected model.

Step 8 Click **Save**.

Step 9 If you need to change the type of the meter, the page modify its initial parameters on the page **Device Monitoring**. See [10.4.2 Configuring Parameters for Meter](#).

--End

15.1.2 Grid-Connected Power Control

Users must first configure the ESS's energy purchase control method and feed-in control method. These thresholds define the system's maximum power limits when connected to the grid, ensuring stability and energy efficiency. These thresholds affect the actual power control range.

Prerequisite

- The web UI has switched to the energy management scenario. See [7.6 Selecting Usage Scenario of Web UI](#).

The **Feed-in power limit** can be set on the **Power Control > Grid-connection Power Regulation** or **Power Control > Active Power** page. In practical applications, if the parameter is configured on both pages, the lower value prevails.

- Step 1** Choose **Power Control > Grid-connection Power Regulation**.
- Step 2** Select **No Limit** or **Purchase Energy with Limited Power** from the **Energy Purchase Control Method** drop-down list.
- Step 3** If **Purchase Energy with Limited Power** is selected, set a proper power limit in **Power Limit for Energy Purchase** based on the rated current of the main power source equipment (e.g., household air circuit breaker) that is connected to the system.
- Step 4** Select **Total active power control** or **Per-phase active power control** from the **Feed-in Control Method** drop-down list.
- **Total active power control** (default): The meter collects data of three phases on the grid side as feedback values for power regulation.
 - **Per-phase active power control**: The meter collects data of a single phase as feedback values for power regulation.

This function is available on LOGGER-SV500.001.00.P012 or later.

- Step 5** If **Per-phase active power control** is selected, select **Three-phase balanced output** or **Three-phase unbalanced output** from the **Power output method** drop-down list.
- **Three-phase balanced output** (default): Limit the power output of each phase based on the maximum feed-in power among the three phases.
 - **Three-phase unbalanced output**: Limit the power output of each phase based on its actual feed-in power.

Three-phase unbalanced output can be configured only if the inverter supports three-phase unbalanced output (i.e., supports per-phase power limitation). Otherwise, **Three-phase balanced output** is displayed by default.

- Step 6** Select whether to enable **Power limitation**. It is disabled by default.
- Step 7** If **Power limitation** is selected, you must enter the target value in **Feed-in power limit** and select the unit, **kW** or **%**.

If **Three-phase unbalanced output** is selected from the **Power output method** drop-down list, you must configure the feed-in power limit separately for phases A, B, and C.

For scenarios with a high feed-in requirement, it is recommended to enable the communication interruption protection and preset power limit ratio for all inverters. To do so, go to the **Device monitoring** page, choose the relevant inverter model, and choose the **Operation parameters** tab to switch on **Communication protection configuration**.

- Step 8** When the unit for target value is set to **kW**, set a reasonable feed-in power value according to local regulations.
- Step 9** When the unit for target value is set to **%**, in the drop-down list **Feed-in Power Limit Ratio Calculation Basis**, select a reference for limiting the grid-connected power.
- **Nominal Power**: Calculate the value to be sent for power control based on the inverter's rated power.
 - **Installed PV Power**: Calculate the value to be sent for power control based on the installed PV capacity. Enter the total installed power of PV modules at the power plant.

- Step 10** Select whether to enable **Swift grid dispatching mode**.

If strict zero export requirements need to be met, it is recommended to enable this mode to achieve faster active power regulation.

Only versions earlier than LOGGER-SV500.001.00.P012 support this step.

- Step 11** **Disable** or **Enable** the **Third-party power generation systems**.

Users can make selection based on actual needs if a third-party inverter is connected in the system.

This step is applicable to LOGGER-SV500.001.00.P007 or later. If you enable **Third-party power generation systems**, the **Channel 2 CT connection** function of all connected DTSU666-20 meters will be enabled.

- Step 12** If **Enable** is selected in **Third-party power generation systems**, users can set the rated power in **Rated power of third-party power generation system (kW)**. Range: 0–99999999. Unit: kW. The default value is 0.

Users can set the **Rated power of third-party power generation system** after evaluating the rated power of the third-party inverter connected.

This step is applicable to LOGGER-SV500.001.00.P007 or later.

- Step 13** Click **Save**.

--End

15.2 Select Energy Management Operating Mode

Users can select the operating mode of the ESS as needed to achieve effective management and utilization of energy.

Before selecting an energy management operating mode, ensure that remote power control is disabled on the current Logger1000.

Logger1000 supports the following operating modes:

Mode	Description
Self-Consumption	Applicable to scenarios where PV output is sufficient to meet the load demand. In this mode, the PV system and battery storage are used to their fullest extent to supply power. Users can achieve energy self-consumption through demand control and battery usage plans.
Time Plan	Applicable to scenarios with significant differences between on- and off-peak electricity prices. Users can reduce electricity costs by setting specific battery charging/ discharging periods and power.
Compulsory Mode	Applicable to scenarios where the ESS needs to respond immediately to charging/discharging commands. Recommended during system installation and commissioning.
AI mode	Applicable to PV-ESS systems with fluctuating and uncertain tariff, weather, and load demand. AI mode predicts PV generation and load demand based on meteorological data and combines real-time tariff to calculate the optimal power dispatch strategy, maximizing system revenue.

15.2.1 Self-Consumption

The self-consumption mode is designed to maximize the use of photovoltaic (PV) generation and battery-stored energy to supply power to loads, thereby reducing electricity drawn from the grid. Additionally, you can set desire battery charging and discharging times based on varying electricity prices to reduce costs.

Energy supply and energy consumption precedence

When PV generation is sufficient, the system prioritizes using solar power to meet load demands, storing excess energy in the batteries. If there is still surplus PV energy, the system feeds the excess back to the grid.

When PV generation cannot meet load demands, the system utilizes stored battery power. If both PV output and battery storage are insufficient, the system draws additional power from the grid.

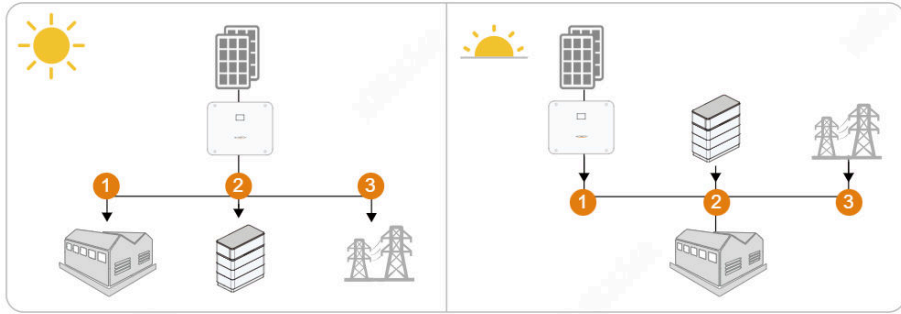

Example

Assuming the PV installation power of the inverter is 10kW, with the inverter's rated power at 5kW, and the maximum charge and discharge power of the battery also at 5kW, the system operates as follows.

When there is sufficient sunlight:

- If the PV generates 7kW and the load demands 3kW, then the surplus of 4kW will be used to charge the batteries.
- If the PV generates 10kW and the load demands 3kW, then the batteries will charge at its maximum capacity of 5kW, and the remaining 2kW will be fed into the grid.

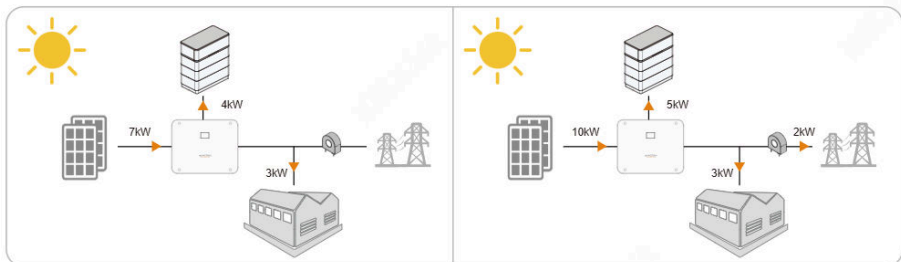

When there is insufficient sunlight:

- If the PV generates 2kW and the load demands 4kW, then the batteries will supply 2kW to meet the load requirements.
- If the PV generates 2kW and the load demands 7kW, then the batteries will discharge at 3kW, and the system will pull an additional 2kW from the grid.

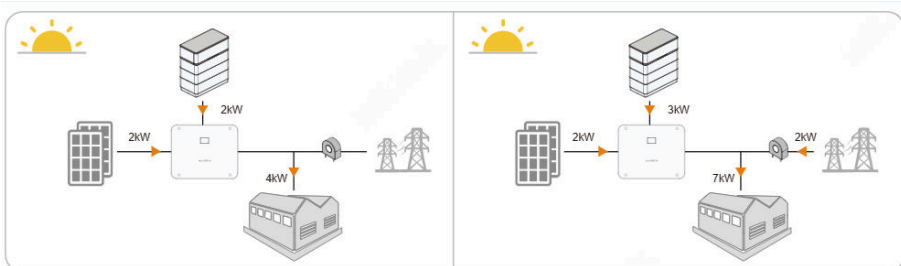

Prerequisite

- The web UI has switched to the energy management scenario.。

Step 1 Click **Energy Management** to navigate to the corresponding page.

Step 2 In the drop-down list **Working Mode**, select **Self-Consumption**.

Step 3 Click **Save**.

--End

15.2.1.1 Demand Control

Demand control refers to setting the power thresholds for drawing from and feeding into the grid by the storage system. In the self-consumption mode, you can adjust power supply and consumption precedence based on different sunlight conditions to either reduce electricity costs or increase feed-in profits. You can set power thresholds according to real situations.

Threshold on Power Feed-in (Demand Control)

Setting the feed-in threshold means setting the power level for feeding electricity back into the grid. When sunlight is sufficient to meet load demands, you can gain economic benefits from feeding surplus electricity into the grid. If there is an abundance of sunlight, it is recommended to configure **Threshold on Power Feed-in (Demand Control)**, so that excess solar energy is fed into the grid first, changing the precedence in which the energy storage system supplies electricity.

After configuration, when there is enough sunlight, the energy storage system first meets the load demands, and then feeds any extra solar electricity into the grid. Only when the **Threshold on Power Feed-in (Demand Control)** exceeds a certain threshold will the excess be used to charge the battery.

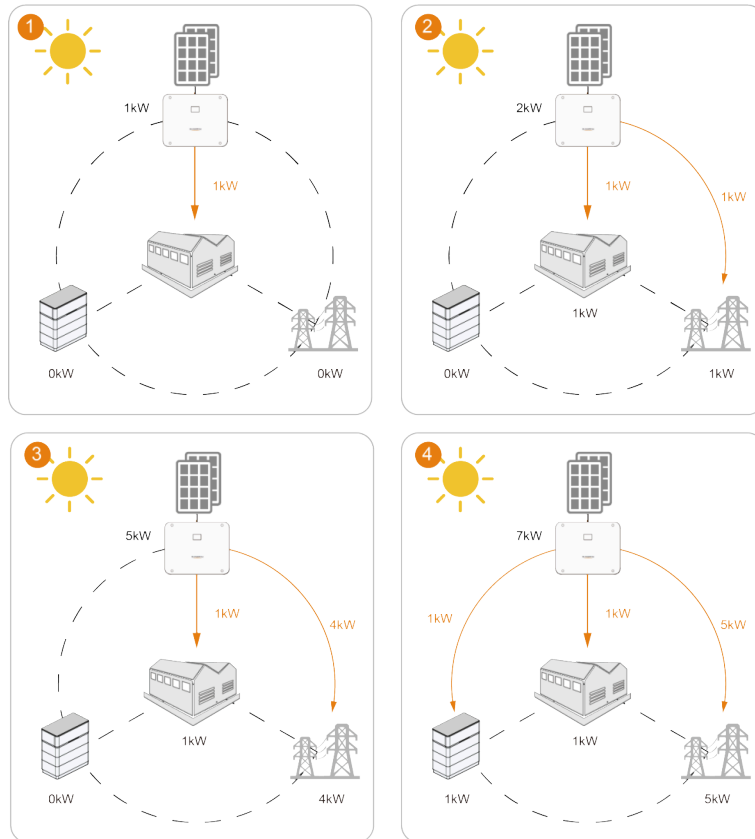

Figure 15-1 Power supply precedence (when **Threshold on Power Feed-in (Demand Control)** is set to 5kw)

Threshold on Power Purchase (Demand Control)

Setting the power purchase threshold means setting the power level for the load to draw electricity from the grid. In some regions, to encourage users to reduce electricity use during peak times and decrease the load on the grid, utility companies charge extra fees based on the peak electricity use within a certain time frame. In such cases, it is recommended to configure **Threshold on Power Purchase (Demand Control)** to change the precedence in which the energy storage system draws power.

After configuration, when sunlight is insufficient and the solar power output is not enough for the load, the storage system controls the load to prioritize drawing power from the grid. When the draw power exceeds the set threshold, the system switches to drawing from the battery, thereby reducing electricity costs.

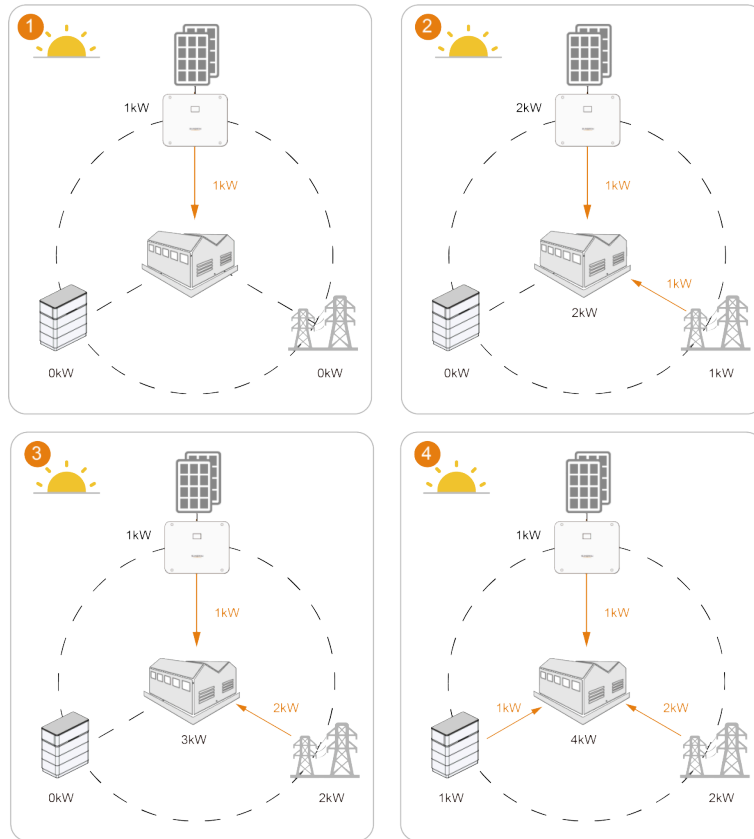

Figure 15-2 Power consumption precedence (when **Threshold on Power Purchase (Demand Control)** is set to 2kw)

Prerequisite

- The working mode for energy management has selected **Self-Consumption**. See [15.2.1 Self-Consumption](#).

Step 1 In the field **Threshold on Power Purchase (Demand Control)**, enter the maximum allowed value for power consumption from the grid (Default value: 0).

Step 2 In the field **Threshold on Power Feed-in (Demand Control)**, enter the maximum allowed grid feed-in power value (Default value: 0).

Step 3 Click **Save**.

--End

15.2.1.2 Adding Battery Usage Plan

Self-Consumption In the self-consumption mode, users can create custom charging/discharging time windows, allowing the system to make the most of the PV output in on-peak hours and charge the battery properly in off-peak hours. In this way, electricity cost is reduced.

Battery discharging and forced charging windows can overlap. If a time window allows both battery discharging and forced charging, forced charging will be executed first.

It is recommended to set periods with high electricity prices as **Allow Discharging** windows and periods with low electricity prices as **Force Charging** windows.

Discharging Windows

The battery is allowed to discharge to supply the loads in a specified **Allow Discharging** time period. The discharging window is all-day by default (24 hours).

Forced Charging Windows



In a specified **Force Charging** time period, the battery is charged at its maximum allowable power until reaching the preset target SOC, unrestricted by **Threshold on Power Feed-in (Demand Control)**. If the PV output cannot meet the battery charging power demand, the system is allowed to charge the battery with energy from the grid. There is no default duration for a forced charging window.

- When PV energy is sufficient, the energy will be first supplied to meet the battery demand, and the remaining energy is supplied to the load. If, after this, there is still energy surplus, it will be fed into the grid.
- When PV energy is insufficient, the system prioritizes charging the battery. If the PV output cannot meet the battery demand, the system is allowed to charge the battery with energy from the grid. The load will also draw power from the grid.

Time Period with No Settings

Outside of the configured time periods, the battery is not allowed to discharge or be charged by drawing power from the grid. In this case, the battery can only be charged by PV power.

- When the PV energy is sufficient, the energy will be first supplied to the loads, with the excess stored in the battery. If, after this, there is still energy surplus, it will be fed into the grid.
- If the PV output is insufficient to meet the load demand and the battery does not discharge, the system will purchase energy from the grid to meet the load demand.

Time Window Status	Description
	When a time window displays the start and end time, it indicates that the discharging or charging time settings have been configured for this period of time.
	<p>Hover over a time window. The color of the time window deepens, indicating that the time window is selected. You can perform the following operations:</p> <ul style="list-style-type: none"> • Drag the time window left or right to adjust its duration. The minimum duration for a time window is 15 minutes. • Click the upper-right corner of the time window to delete it.

Prerequisite

- The Working mode for energy management is set to **Self-Consumption**. See [15.2.1 Self-Consumption](#).

Step 1 Enable **Custom Season**.

By default, a month span is displayed with all 12 months selected.

Step 2 Set the desired month span under **Select Month**.

You can set different time windows based on seasonal energy demand patterns.

Step 3 In the **Time Period** drop-down list, select the days on which the battery charging/discharging plan applies.

You can apply the charging/discharging plan to all days, or set different charging/discharging plans for working days and non-working days. The plan applies to every day by default.

- **Every Day**: The default option, indicating the set charging/discharging plan applies on all days. This option is ideal for scenarios where the daily energy demand is relatively stable.
- **Working days and non-working days**: Set different charging/discharging plans for working days and non-working days.

Step 4 If **Every Day** is selected, set the battery discharging and forced charging windows.

- Tap a time period in the **Allow Discharging** time bar. Then, drag the left or right edge of the window to adjust the length of time. A new discharging window will be created (1 hour by default).
- Tap a time period in the **Force Charging** time bar. Then, drag the left or right boundary of the window to adjust the length of time. A new forced charging window will be created (1 hour by default).
- Click the time window. Click the added time window, and in the pop-up dialog box, enter the target charging SOC in **Target SOC**.

Step 5 If **Working days and non-working days** is selected, click Weekday Non-working days to configure battery discharging time and forced charging time separately for working days and non-working days.

By default, working days are Monday to Friday, and non-working days are Saturday and Sunday. Click  to flexibly define working days and non-working days.

This function is available on LOGGER-SV500.001.00.P012 or later.

Step 6 To add more month spans, click **Add** to the right of the default month span name.

Click  to the right of a month span to modify its name or delete it.

Step 7 Click **Save**.

--End

Example

Given the inverter PV installed power is 10 kW, the inverter rated power is 5 kW, and the maximum charging/discharging power of the battery is 5 kW.

When a 14:00–24:00 **Allow Discharging** window and a 00:00–08:00 **Force Charging** window are set, and **Target SOC** is set to "100%", the system allocates energy as follows:

- 00:00–08:00: When the battery SOC falls below **Target SOC**, power is drawn from the grid to charge the battery until the SOC requirement is met, then charging stops.
- 08:00–14:00: No settings are configured for this period. If PV output cannot meet the load demand, the battery is not allowed to discharge, and the system will directly purchase power from the grid. If the battery power is insufficient, the system only uses PV power to charge the battery.
- 14:00–24:00: When PV output cannot meet the load demand, the system controls the battery to discharge.

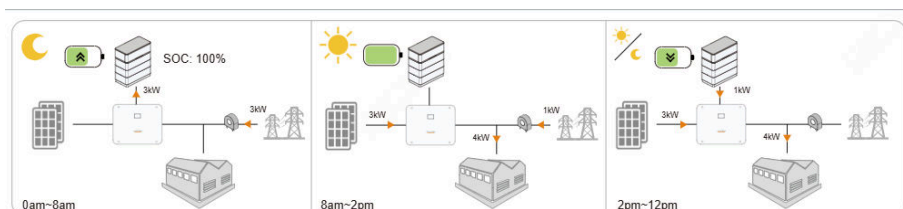

15.2.2 Time Plan

The time plan mode mainly used in energy trading scenarios, leveraging differences between peak and off-peak pricing to manually set times and powers for battery charging and discharging to maximize economic benefits.

According to the TOU electricity prices, it is recommended to set the peak hours as **Discharge**, and the off-peak hours as **Charge**.

Charging time

When a new charging time period is added, in the specified time period, the battery charges with the excess PV output according to the defined charging power until a full charge.

- When the PV output is sufficient, the system prioritizes the battery needs with the PV energy, with the excess output supplying the loads. After supplying the loads, the remaining PV power is directed to charge the battery. After a full charge, the remaining PV output, if any, is fed to the grid.
- When PV generation is insufficient, the system prioritizes battery charging. If solar power generation cannot meet the battery's needs, the system will purchase electricity from the grid. The loads also draw power from the grid.

The discharging time and charging time must not overlap.

Discharging time

When a new discharging time period is added, in the specified time period, the battery discharges according to the defined discharging power. The excess PV output, if any, is consumed first to reduce the battery discharging power. When the battery discharging power is reduced to zero, the remaining excess PV power is directed to charge the battery to maximize the self-consumption of the PV power.

Time periods without specific settings

Within the time periods with no settings, the function **Perform self-consumption in remaining time** is disabled, and the battery will not discharge. In this case, only PV output is used to charge the battery. If the function is enabled, the battery charging and discharging will depend on the value **Discharge cut-off SOC when idle** in the following ways:

- When the battery SOC is higher than the set value, the battery is allowed to discharge and charge from the PV output.
- When the battery SOC is lower than the set value, the battery is not allowed to discharge but can charge from the PV output.

15.2.2.1 Selecting the Time Plan Mode

Prerequisite

- The web UI has switched to the energy management scenario.

Step 1 Click **Energy Management** to navigate to the corresponding page.

Step 2 In the drop-down list **Working Mode**, select **Time Plan**.

Step 3 Click **Save**.

--End

15.2.2.2 Configuring Battery Usage Plan

Prerequisite

- The Working mode for energy management is set to **Time Plan**. See [15.2.2 Time Plan](#).

Step 1 Choose **Energy Management**.

Step 2 Select **Time Plan** from the **Working Mode** drop-down list.

Step 3 Set the desired month span under **Select Month**.

You can set different time windows based on seasonal energy demand patterns.

Step 4 In the **Time Period** drop-down list, select the days on which the battery charging/discharging plan applies.

You can apply the charging/discharging plan to all days, or set different charging/discharging plans for working days and non-working days. The plan applies to every day by default.

- **Every Day**: The default option, indicating the set charging/discharging plan applies on all days. This option is ideal for scenarios where the daily energy demand is relatively stable.
- **Working days and non-working days**: Set different charging/discharging plans for working days and non-working days.

Step 5 If **Every Day** is selected, set the battery discharging and forced charging windows.

- Tap a time period in the **Discharge** time bar. Then, drag the left or right edge of the window to adjust the length of time. A new discharging window will be created.

The time window is measured in hours by default.

- Click the time window. In the **Power** field, enter the discharging power for the battery.
- Tap a time period in the **Charge** time bar. Then, drag the left or right edge of the window to adjust the length of time. A new charging window will be created.
- Click the time window. In the **Power** field, enter the charging power for the battery.

Step 6 If **Working days and non-working days** is selected, click  to configure battery discharging time and forced charging time separately for working days and non-working days.

By default, working days are Monday to Friday, and non-working days are Saturday and Sunday. Click  to flexibly define working days and non-working days.

This function is available on LOGGER-SV500.001.00.P012 or later.

Step 7 You must set the **Discharge cut-off SOC when idle**. The battery will be allowed to discharge until the set Cut-off SOC of discharge is reached in a time period with no settings.

This function is available on LOGGER-SV500.001.00.P012 or later.

Step 8 To add more month spans, click **Add** to the right of the default month span name.

Click  to the right of a month span to modify its name or delete it.

Step 9 Click **Save**.

--End

15.2.3 Compulsory Mode

The compulsory mode is mainly used for battery operation and maintenance, enabling the battery to function based on specific charging and discharging settings. After maintenance, restore the system to its original working mode.

Prerequisite

- The web UI has switched to the energy management scenario.

Step 1 Click **Energy Management** to navigate to the corresponding page.

Step 2 In the drop-down list **Working Mode**, select **Compulsory Mode**.

Step 3 In the drop-down list **Charging/Discharging Command**, select the required action.

- **Charge**: The battery charges at the set power level until it is fully charged.
- **Discharge**: The battery discharges at the set power level until it is fully discharged.
- **Stop**: Manually stop the battery from charging or discharging. The batteries will enter the standby mode.

Step 4 If **Charge** or **Discharge** is selected, in the field **Charging/Discharging Power**, specify the desired power level for charging or discharging.

Step 5 Click **Save**.

--End

15.2.4 AI Mode

AI mode predicts PV generation and load demand based on meteorological data and combines real-time tariff to calculate the optimal power dispatch strategy, maximizing system revenue. A certain amount of data accumulation is required for AI mode to predict future production and consumption more accurately.

Prerequisite

The web UI has switched to the energy management scenario. See [7.6 Selecting Usage Scenario of Web UI](#).

This function is available on LOGGER-SV500.001.00.P012 or later.

If the system is integrated with chargers, the AI mode is not displayed.

Step 1 Choose **Energy management > Energy management mode**.

Step 2 Select **AI mode** from the **Operating mode** drop-down list.

Step 3 Enable or disable **Storm protection** as needed.

- If **Storm protection** is enabled, upon receiving an extreme weather alert, the system charges at maximum capacity until reaching the SOC upper limit, ignoring all the preset restrictions. When the extreme weather ends, the system will go back to the previous working mode.
- Disable (default): The system will work as per the set working strategy.

Step 4 Click **Save**.

--End

15.2.5 System Power Backup

System power backup is mainly used for emergency power backup in off-grid scenarios. This mode can be enabled by the user as needed, and it will take effect once the settings are applied. In this mode, the system will charge the battery until reaching the reserved battery SOC for off-grid.

This feature is available on LOGGER-SV500.001.00.P012 or later.

Step 1 Choose **Energy management > System power backup**.

Step 2 Enable the **Off-grid mode**.

Step 3 Enter the **Reserved battery SOC for off-grid (%)**. Range: 10–100; 10 by default.

Step 4 Click **Save**.

--End

15.3 Set On/Off-Grid Switching

The on/off-grid switching is applicable to commercial and industrial ESS scenarios. When the grid is available, power is supplied to the load through the grid. In the event of a grid outage, the ESS quickly switches to off-grid mode to ensure continuous power supply to the load. The system can also serve as a backup power source, reducing the reliance on diesel generators.

This feature is available on LOGGER-SV500.001.00.P015 or later.

The on/off-grid switching function is mutually exclusive with third-party PV scenarios and cannot be used at the same time.

Step 1 Choose **Energy management > On/off-grid switching**.

Step 2 Select a **Generator connection** method (Not installed by default).

- **Not installed:** No diesel generator is connected.
- **Grid port:** The diesel generator is connected through the grid port.

Step 3 Enable the **Whether connected to the grid** switch (disabled by default).

- **Disable:** Only diesel generator connection is allowed. Grid connection is not allowed.
- **Enable:** Both the grid and the diesel generator can be connected. The grid is used first, and the ATS automatically performs adaptive switching.

Step 4 If diesel generator connection is allowed, enter values in the **Maximum generator charging power to battery** and **Generator rated power** text boxes.

- **Maximum generator charging power to battery:** The maximum power allowed by the system when the diesel generator charges the energy storage battery.
- **Generator rated power:** The maximum output power of the diesel generator. Set this value based on the rated power of the connected generator.

Maximum generator charging power to battery must not be greater than **Generator rated power**.

Step 5 Set **Generator control mode**.

- **Forced start:** The user forces the diesel generator to start.
- **Forced stop:** The user forces the diesel generator to stop.
- **Manual control:** The user manually starts and stops the generator through an external switch.
- **Controlled by SOC:** The generator starts and stops based on the battery SOC.

Step 6 If **Controlled by SOC** is selected, enter values in the **Battery SOC threshold for generator startup** and **Battery SOC threshold for generator shutdown** text boxes. By default, the Battery SOC threshold for generator startup is 20%, and the Battery SOC threshold for generator shutdown is 90%.

- When the battery SOC falls below the Battery SOC threshold for generator startup, the diesel generator starts. It supplies power to the load first, and then charges the battery based on the remaining generator power and the Max. permitted charging power from AC.
- When the battery SOC exceeds the Battery SOC threshold for generator shutdown, the diesel generator stops.

The interval between two consecutive diesel generator startups must be greater than 30 seconds.

Step 7 Select **Enable** or **Disable** from the **Generator night mode** drop-down list. It is disabled by default.

When Forbid generator night-time operation is enabled, the diesel generator cannot be started during the configured operation forbidden period (except in Manual control mode and Forced start).

Step 8 If Forbid generator night-time operation is enabled, enter values in the following text boxes:

Operation forbidden start time: hour (h), Operation forbidden start time: minute (min), Operation forbidden end time: hour (h), and Operation forbidden end time: minute (min).

Step 9 Click **Save**.

--End

16 Charger Control

In industrial and commercial scenarios, chargers serve as intelligent terminal loads when integrated with a PV system, forming an intelligent PV charging system that can enhance the operational efficiency of PV power plants and increase user profits.

Firmware version LOGGER-SV500.001.00.P007 and above support this function.

16.1 Application Scenarios

- Charger control strategies are only applicable to PV systems.
- To ensure stable communication, chargers are connected to a router or a switch via Ethernet, and can be monitored and maintained through iSolarCloud.
- The total number of chargers and meters connected to a plant where the Logger1000 is deployed cannot exceed 30.

Third-Party PV Scenario

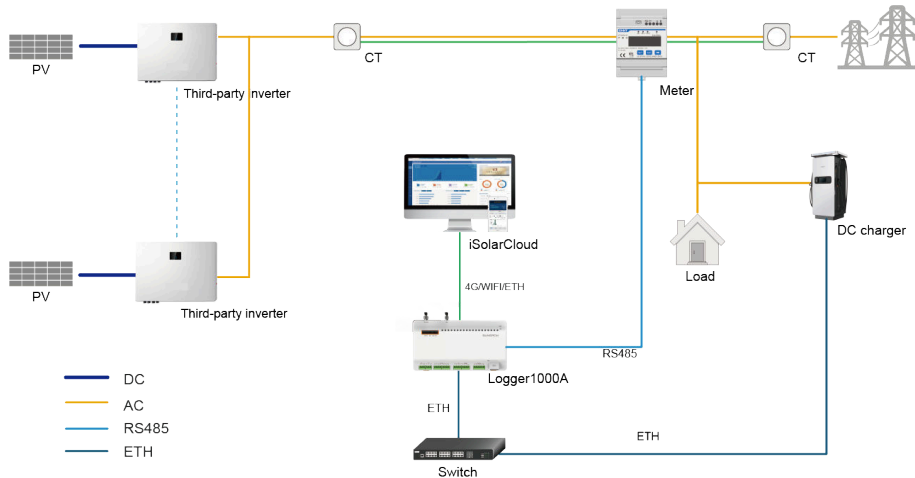

The compatible devices are listed below.

PV inverter	Meter	Charger
Third-party inverter	DTSU666-20	IDC30E IDC180E

PV inverter	Meter	Charger
-------------	-------	---------

- Only gateway meters can be used in the system. Each DTSU666-20 meter is used together with two current transformers.
- For successful upload of Channel 2 data when a DTSU666-20 meter is connected to the system, you must enable the **Channel 2 CT Connection** function. By default, this function is disabled.

IDC30E has one charging connector and supports a minimum charging current of 2 A. IDC180E has two charging connectors and supports a minimum charging current of 1 A.

Self-Developed PV Scenario

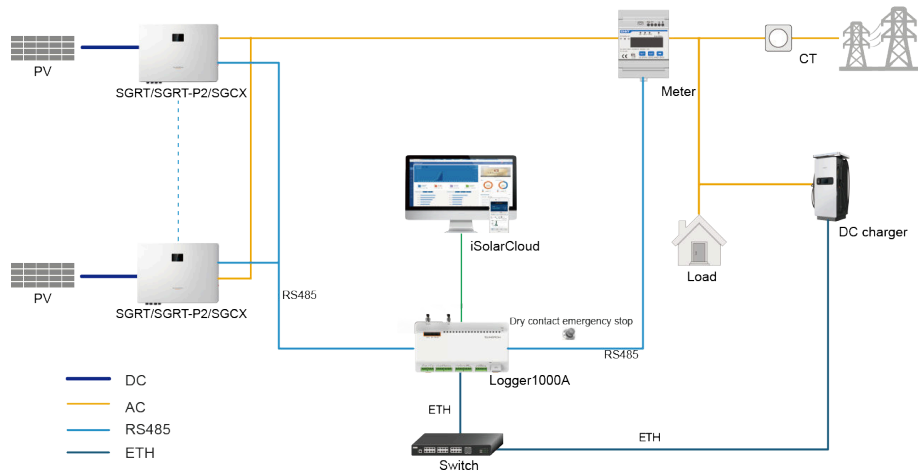

The compatible devices are listed below.

PV inverter	Meter	Charger
SGRT/SGRT-P2/SGCX series	DTSU666-20 DTSD1352	IDC30E IDC180E

PV inverter	Meter	Charger
	<p>Only gateway meters can be used in the system. The meter and the current transformer are connected at the gateway port.</p>	<p>IDC30E has one charging connector and supports a minimum charging current of 2 A. IDC180E has two charging connectors and supports a minimum charging current of 1 A.</p>

16.2 Charger Management

16.2.1 Adding Chargers

Prerequisite

Chargers operate in OCPP mode by default. Before adding a charger on the Logger1000's Web UI, you must enable EMS mode through iEnergyCharge or the liquid crystal display (LCD) screen of the charger.

- Step 1** Navigate to the page **Device > Device List** and click **Add Device** to open the **Add Device** dialog box.
 - Step 2** In the drop-down list **Device Type**, select **Charger**.
 - Step 3** In the drop-down list **Port**, select **NET**.
 - Step 4** In the drop-down list **Protocol Type**, select **MODBUS-TCP**.
 - Step 5** In the fields **Peer IP Address** and **Peer Port**, enter the IP address and port number of the charger, respectively.
 - Step 6** In the drop-down list **Device Model**, select the model of the charger.
 - Step 7** Enter the beginning address of the chargers in the field **Beginning Address** and the number of chargers to be added in the field **Quantity of Device** based on the selected model.
 - Step 8** Click **Save**.
- End

16.2.2 Configuring Parameters for Chargers

- Step 1** Click **Device Monitoring** to navigate to the corresponding page.

Step 2 From the device list on the left, select the charger whose control parameters you want to configure.

Step 3 On the right, select the tab page **Control Parameters** to modify the charger's control parameters.

- In the field **Charger Enable/Disable**, select one of the following options:
 - **Enable**: Enables the charger. If the charger is enabled, other control parameters can be configured.
 - **Disable**: Disables the charger. If the charger is disabled, other control parameters cannot be configured.
- In the field **Charger Output Power**, enter the output power of the charger.
- In the fields **Connector 1 Output Power Setting** and **Connector 2 Output Power Setting**, enter the output power of Connector 1 and Connector 2, respectively.
- In the fields **Charger Connector 1 Start/Stop** and **Charger Connector 2 Start/Stop**, select **Start** or **Stop** to configure the start/stop of the charging connectors.

Determine whether multiple charging connectors exist based on the displayed charging connectors of the connected charger. IDC30E has one charging connector and IDC180E has two charging connectors.

Step 4 Click **Settings** in the upper right corner to save the control parameter settings of the charger.

--End

16.2.3 Viewing Charger Information

After adding a charger and configuring the control parameters for the charger, you can view the real-time data and device information of the charger.

Step 1 Click **Device Monitoring** to navigate to the corresponding page.

Step 2 From the device list on the left, select the charger whose information you want to view.

Step 3 Click the **Realtime Values** tab on the right to view the real-time data of the charger.

Step 4 Click the **Device Information** tab on the right to view the **Device S/N**, **Device Model**, **Max. Charging Power of Charger**, and **Current Version** of the charger.

--End

16.2.4 Rebooting Chargers

Step 1 Click **Device Monitoring** to navigate to the corresponding page.

Step 2 From the device list on the left, select the charger that you want to reboot.

Step 3 Click the **Device Instruction** tab on the right and click **Reboot** to reboot the charger.

--End

16.3 Charger Energy Control

Prerequisite

- Charger control strategies are only applicable to PV systems. The web UI has switched to the data acquisition scenario.
- DTSU666-20 or DTSD1352 gateway meters are added to the Web UI.

Step 1 Click **Charger Control** to navigate to the corresponding page.

Step 2 In the drop-down list **Meter**, select a meter.

Step 3 In the drop-down list **Energy Purchase Control Method**, select an energy purchase control method. Default value: **No Limit**.

- **Purchase Energy With Limited Power:** Select this method to set an upper power limit on energy purchase in the **Power Limit for Energy Purchase** field. Range: 0–999999.99. Default value: 0. Unit: kW.

The **Power Limit for Energy Purchase** value must be greater than the sum of the minimum charging powers of all charging connectors.

- **No Limit:** There is no energy purchase limit.

Step 4 In the drop-down list **Multi-Charger Control Strategy**, select a multi-charger control strategy to distribute power across chargers based on the preset strategy to meet the varying demands of different users. Default value: **First Come First Charged**.

- **First Come First Charged:** Based on charger sequence and grid power limits, allocate power according to electric vehicle (EV) needs, prioritizing earlier-sequence EVs for quicker charging.
- **Power Distributed Evenly:** Allocate charging power evenly according to the quantity of EVs and grid power limits.

Step 5 In the drop-down list **Charging Mode**, select a charging mode. Default value: **Eco & Economic Charging**.

- **Eco & Economic Charging:** The PV power will be first used for the loads, with any surplus supplied to the EV charger. If the surplus falls below the charger's minimum charging power, the system will either ensure the minimum charging power for the charger or stop charging, depending on whether drawing power from the grid is allowed.

If Charging Mode is set to **Eco & Economic Charging**, you can configure the **Allow Power Purchasing or Not** parameter. Default value: Yes. Setting the value to **No** may interrupt the charging process. To continue charging in this case, you need to disconnect and then reconnect the charging connector.

- **Eco & Fast Charging:** The EV charger maximizes the use of PV energy. If PV power exceeds the charger's minimum charging power, no additional power will be drawn from the grid. Conversely, if PV power falls short, the charger can supplement with grid power to meet the minimum charging power.

- **Fast Charging:** The EV charger can use both PV energy and grid energy. In this mode, the charger operates at the rated power, delivering the exact power required by the EV.
- **No Control:** The EV charger is not under the control of power dispatch commands.

Step 6 Click **Save**.

--End

17 Maintaining the Data Logger

17.1 Setting System Time

Ensure the Logger1000's system time is accurate. Both manual and automatic time synchronization methods are supported.

During commissioning, it is recommended to synchronize with the local machine time using **User Define**. If the Logger1000 is connected to the Internet, prioritize time synchronization with iSolarCloud. If iSolarCloud is not accessible, use NTP (Network Time Protocol) for time synchronization.

Step 1 Click **System > System Time** to navigate to the corresponding page.

Step 2 In the drop-down list **Clock Source**, select the preferred time synchronization method.

The following time synchronization methods are supported:

- **User Define**: Manually set the current time and time zone of the Logger1000.
- **NTP**: Synchronize the time of the Logger1000 with the server's time.
- **IEC104**: Synchronize the clock using the IEC 104 communication protocol.
- **iSolarCloud**: Synchronize the Logger1000's time with iSolarCloud.

Please ensure that the Logger1000 communicates properly with iSolarCloud.

- **Modbus-TCP**: Synchronize the clock over TCP/IP networks using the MODBUS-TCP protocol.

Step 3 Click **Save**.

Step 4 Check **Inverter Timing** to synchronize the Logger1000's time with that of connected SUNGROW inverters.

--End

17.2 Enabling Remote Maintenance

After remote maintenance is enabled, O&M users can access the Web UI through the remote maintenance link and user authentication information.

Step 1 Click **System > Remote Maintenance** to navigate to the corresponding page.

Step 2 In the drop-down list **Remote Maintenance Switch**, select **Enable**.

Step 3 Select the corresponding server.

The server address is associated with the iSolarCloud forwarding Modbus ID. If you need to change it, modify the iSolarCloud server.

Step 4 Click **Save** to open the **Remote Access** dialog box.

Step 5 Enter the login password and click **Confirm**.

A remote maintenance link will be created.

Step 6 Click **Copy Remote Access Information** to save the access information locally.

Step 7 In the field **Email**, enter the desired email address to receive the access information, and click **Send**.

--End

17.3 Updating the Logger1000

You can update the Logger1000's firmware via the Web UI.

- For the required tools and resource files for the update, contact SUNGROW.
- The update package file must be in .zip format.
- For Logger1000 with firmware version P007 or later, in O&M mode, the Web system can be updated to a later version, but reverting to an earlier version is not allowed. To revert to an earlier version, switch to R&D mode first.

Step 1 Click **System > System Maintenance** to navigate to the corresponding page.

Step 2 Click **System Update**, in the dialog **Select a Firmware File**, select an update method.

The following update methods are supported:

- **Local Update Package:** In the resource window, choose the firmware file and verify the matching devices.
- **Online Update Package:** Obtain the firmware package through the iConfig tool and proceed with the update.
- **iSolarCloud Upgrade Package:** Use the online firmware package available through iSolarCloud to update the device.

Step 3 Follow the on-screen instructions to complete the update process.

A confirmation dialog box appears. Upon confirmation, the Logger1000 will automatically restart to apply the firmware update. The new firmware will take effect after a reboot.

--End

17.4 Restarting Logger1000

Step 1 Click **System > System Maintenance** to navigate to the corresponding page.

Step 2 Click **Rebooting**.

Step 3 In the prompt, click **Confirm**.

--End

17.5 Restoring to the Factory Settings

This will restore all modified Logger1000 settings to the factory state.

Step 1 Click **System > System Maintenance** to navigate to the corresponding page.

Step 2 Click **Reset All Settings**.

Step 3 In the prompt, click **Confirm** to restore all parameters to the default settings.

--End

17.6 Viewing the Firmware Version

Check the firmware information of the Logger1000.

Step 1 Click **About** to navigate to the corresponding page.

Step 2 Under **Version**, click the corresponding to **Value** for five times to view the following information.

Firmware Information	
Name	Value
Device S/N	A2261658059
Version	M_Logger1000_V01_V01_A

The firmware version of the Logger1000 is identified by Application Software Version, formatted as "LOGGER-SV500.001.00.P[XXX]". For easier recognition, the firmware version is often shortened and referred to as "P[XXX]."

--End

To add this Data Logger to iSolarCloud, simply scan the QR code on the page **About** using iSolarCloud App. The App will automatically detect the Data Logger's serial number.

17.7 Viewing History Operations

Click **History Data > Operation Log** to navigate to the corresponding page.

You can review a log of past activities or changes made within the system.

17.8 Certificate Management

Users can import HTTPS, IEC104, and Modbus TCP certificates for the Logger1000 and view details about the IEC104 and Modbus TCP certificates.

This feature is available on LOGGER-SV500.001.00.P007 or later.

Pre-configured Certificate Risk Statement

Certificates are pre-configured on SUNGROW devices during the manufacturing process as their necessary identity credentials. Regarding the use of these pre-configured certificates, please note the following:

- Pre-configured certificates are only used to establish an initial secure channel for the device to access the customer network during the deployment process. SUNGROW does not promise or guarantee the security of the pre-configured certificates.
- SUNGROW does not promise or guarantee the security of the pre-configured certificates when used in services. It is recommended that users replace them with their own secure certificates.
- The validity period for the HTTPS, IEC104 and Modbus TCP certificates pre-configured by SUNGROW is 25 years. Once a pre-configured certificate expires, services using the certificate can still communicate.
- If users choose to use their own certificates, it is recommended that they properly manage the certificate lifecycle. Certificates with a short validity period are recommended to ensure security.

Steps

- Step 1** Navigate to **System > Certificate Management**. Three types of certificate are available here: HTTPS, IEC104, and Modbus TCP.
- Step 2** To import an HTTPS certificate, for example, click **Import Certificate**. Then, in the pop-up window, click  to select the .crt certificate file and the .key private key file.
- Step 3** Click **Confirm**. Once the files are successfully imported, a prompt will appear asking whether to restart the system.
- Step 4** Click **Certificate Information** on the **IEC104 Certificate** or **Modbus TCP Certificate** tab page to view the detailed information about the certificate, including version, S/N, signature algorithm, validity period, public key, issuer, and user.
- End

17.9 Communication Settings

- This function is available on Logger-SV500.001.00.P010 or higher.

17.9.1 Communication Settings in iSolarCloud

- Step 1** In the navigation bar, click **System > Communication settings** and then click the **iSolarCloud** tab.
- Step 2** You can enable/disable **Communication master switch** (enabled by default). If it is disabled, the device will disconnect from iSolarCloud, monitoring and O&M services from iSolarCloud for the device are discontinued, and you cannot switch servers in the built-in Web.

- Step 3** You can enable/disable **Cloud-to-device** (enabled by default). If it is disabled, iSolarCloud will no longer be able to perform downlink communication with the device.
- Step 4** The downlink communication setting manages sub-level switches, including parameter settings, live data, layout, firmware update, log export, IV scan, and remote maintenance, all of which are enabled by default. If one of the switches is disabled, the device will no longer respond to the relevant commands from iSolarCloud.

Communication master switch, Cloud-to-device, and specific downlink communication functions form a three-tiered top-down control chain. Closing the switches at the previous level will automatically disable all switches at the next lower level, and the operation pages for those lower-level switches will no longer be displayed.

--End

17.9.2 Communication Settings in Third-Party Cloud

- Step 1** In the navigation bar, click **System > Communication settings** and then click the **Third-party cloud** tab.
- Step 2** You can enable/disable **Third-party cloud** (enabled by default). If it is disabled, the device will be disconnected from the third-party cloud, and monitoring and O&M services from the third-party cloud are discontinued.

--End

18 User Management

An administrator can create O&M user accounts, reset account passwords, set parameters related to account protection and session security, and enable or disable research and development (R&D) debugging mode.

Prerequisite

- An Administrator account is required to proceed with the operations below.

This feature is available on LOGGER-SV500.001.00.P014 or later.

18.1 User Roles and Permissions

The following user roles are available in the Web system:

- O&M user
- General user
- Developer
- Administrator

The "Developer" account is available only for SUNGROW technical support personnel.

Permission	Role		
	O&M user	General user	Administrator
View real-time plant data	✓	✓	✗
Configure port parameters of the data logger	✓	✗	✗
Configure data logger forwarding service	✓	✗	✗
Manage the device	✓	✗	✗
Set device parameters	✓	✗	✗
Export data	✓	✗	✗
Power control	✓	✗	✗

Permission	Role		
	O&M user	General user	Administrator
Switch the application scenario of the data logger	✓	×	×
Maintain the data logger system	✓	×	×
View all O&M and general user accounts	×	×	✓
Create or delete O&M and general user accounts	×	×	✓
Reset account passwords	×	×	✓
Set parameters related to account protection and session security	×	×	✓
Enable O&M mode	×	×	✓

18.2 Default Accounts and Passwords

Username	Role	Default Password
maintain	O&M user	pw1111
Defined by the administrator during account creation	General user	Defined by the administrator during account creation
administrator	Administrator	pw@111111
develop	Developer	Dynamically generated

18.3 Setting Up Administrator Account

The system administrator account must be associated with an email or phone number. This ensures that if you forget your password, it can be reset through verification via your phone or email.

Step 1 Click **Link Account** to navigate to the corresponding page.

Step 2 Enter the necessary contact information.

Depending on the interface language, you can associate the account with the following:

- Email address

- Phone number

If both an email address and phone number are added, the system will prioritize the phone number for verification purposes in the event of password recovery.

Step 3 Click **Save**.

Step 4 To delete the associated email or phone number from the account, click **Unlink**.

--End

18.4 Create User Accounts

An administrator can create additional operation and maintenance (O&M) user accounts and general user accounts to meet the team's O&M needs.

O&M user accounts: An O&M user account "maintain" is provided by default to access the Web system and cannot be deleted. In addition to the "maintain" account, the administrator can create 4 more O&M user accounts.

General user accounts: Assigned and provided after the administrator creates the accounts.

Username Requirements

- The name can contain uppercase letters, lowercase letters, numbers, and underscores;
- The name must start with a letter.
- The name should be 4–16 characters long.

Password Requirements

- Passwords should contain at least 3 of the following 4 character types: uppercase letters, lowercase letters, numbers, and special characters.
- Password should be 8–32 characters long.

Step 1 In the navigation bar, choose **User Management**.

Step 2 Click **Add** to open the **Add User** dialog box.

Step 3 Set the username and password.

Step 4 From the **Permission** dropdown list, select **O&M User** or **General users**.

Step 5 Click **Confirm**.

--End

18.5 Delete User Accounts

Step 1 In the navigation bar, choose **User Management**.

Step 2 In the **Action** column for the corresponding user accounts, click the icon .

Step 3 Click **Confirm** in the confirmation dialog box to delete this user account.

Step 4 Click **Clear Users** to delete all user accounts except "maintain".

--End

18.6 Resetting Account Password

18.6.1 Reset Account Password

Step 1 In the navigation bar, choose **User Management**.

Step 2 In the **Action** column of the corresponding user accounts, click  to open the **Modify User** dialog box.

Step 3 Reset your password.

Step 4 Click **Confirm**.

--End

18.6.2 Resetting Administrator Account Password

Step 1 Open the Logger1000's login page.

Step 2 Enter the username: administrator.

Step 3 Click **Forgot Password** to open the **Modify Password** dialog box.

Step 4 Enter the private key.

You can receive the private key via the email or phone number associated with the administrator account.

If the administrator account is not associated with an email or a phone number, contact SUNGROW Customer Service.

Step 5 Enter the new password and confirm.

Step 6 Click **Confirm**.

--End

18.7 Setting Account Security Parameters

To enhance account security, you can configure the related parameters to control login behavior and session validity.

Step 1 Click **Login Management** to navigate to the corresponding page.

Step 2 Modify account security related parameters:

The following parameters can be configured:

- **Number of Illegal Visits:** Specify how many times a user can attempt to log in. An account will be auto-locked if the number of incorrect password attempts exceeds this limit. (Range: 3-6; Default: 6)
- **Login Timeout:** Specify a duration of inactivity after which the system will automatically log the user out, requiring re-authentication. (Range: 10-30; Default: 10)

- **User Lock Time:** Set the duration before a locked account, due to consecutive failed sign-in attempts, is automatically unlocked. (Range: 10-30; Default: 10)

Step 3 Click **Save**.

--End

18.8 Enabling the O&M Mode

To permit the R&D user to access the Web UI, the administrator needs to activate **R&D Debugging**.

Step 1 Click **R&D Management** to navigate to the corresponding page.

Step 2 Turn on the switch.

The switch will automatically turn off after being turned on continuously for 24 hours. By default, this switch is turned off.

--End

18.9 Operating System User Accounts

Below are the default usernames and passwords of the Logger1000 operating system.

Username	Default Password
root	No default password
bin	No default password
daemon	No default password
sys	No default password
sync	No default password
diag	No default password
sg	Dynamic password
sshd	No default password

19 Troubleshooting

⚠ DANGER

Improper grounding may cause fatal electric shock!

⚠ DANGER

Damaged product or system failures may cause electric shock or fire!

- Visually inspect the device for damage or other hazards before troubleshooting.
- Ensure all connections are secure.

NOTICE

Be sure to restart the device only after the fault has been fully resolved to prevent fault expansion or device damage.

Problem	Causes and Corrective Measures
All indicators remain off	<p>The power supply terminal of the Logger1000 has no power connection. Ensure the Logger1000 is connected to the power box.</p>
	<p>Power supply failure Check power supply and input voltage with a multimeter.</p>
	<p>Logger1000 failure Replace the power supply if needed.</p>
Not all devices are being detected	<p>The RS485 port is not connected to any devices or the connection cable is loose or connected reversely. Check and secure RS485 connections.</p>
	<p>Incorrect RS485 communication parameters Verify RS485 serial parameters for baud rate and communication address.</p>
	<p>Devices like meteo station or energy meter not manually added Manually add the devices,</p>
	<p>Mismatched device address</p>

Problem	Causes and Corrective Measures
	<p data-bbox="648 246 1139 276">Verify and correct the device address settings.</p> <hr/> <p data-bbox="648 305 869 335">Device malfunction</p> <p data-bbox="648 344 1016 374">Check the device operation status.</p>
Device disconnected	<p data-bbox="648 403 1166 433">Loose or disconnected communication cable</p> <p data-bbox="648 442 1047 472">Check and secure cable connections.</p> <hr/> <p data-bbox="648 501 869 531">Device malfunction</p> <p data-bbox="648 540 1139 570">Power on the device and confirm connections.</p> <hr/> <p data-bbox="648 599 1131 629">Device removed or configuration changed</p> <ul data-bbox="648 638 1139 687" style="list-style-type: none"> <li data-bbox="648 638 1139 668">• Rescan or manually add replaced devices. <li data-bbox="648 678 1139 687">• Delete removed devices on the Web UI.
Cannot communicate with the backend	<p data-bbox="648 717 1131 785">Logger1000 cannot communicate with the backend</p> <p data-bbox="648 795 1223 864">Check whether the Logger1000 is correctly connected to the PC or router.</p> <hr/> <p data-bbox="648 893 1100 923">Incorrect data forwarding configuration</p> <p data-bbox="648 932 893 962">Verify network settings.</p> <hr/> <p data-bbox="648 991 1223 1021">The forwarding protocol configuration is incorrect</p> <p data-bbox="648 1030 1023 1060">Check forwarding protocol settings.</p>

If these troubleshooting steps don't resolve your issues, please contact SUNGROW.

20 FAQ

20.1 Solution to Insecure HTTPS Connection

Issue

When users try to access Logger1000 via the HTTPS protocol, the browser prompts "Your connection is not private."

Cause

As the HTTPS protocol used by Logger1000 is a self-signed certificate and not authenticated by a certificate authority (CA); therefore, the browser cannot verify its identity and raises a security alarm. Although the self-signed certificate is encrypted as strongly as other authenticated certificates and ensures the communication security in the controlled or internal environments, this alarm may impact users' confidence in the device security.

Solution

1. Obtain the certificate in either of the following ways:
 - Contact SUNGROW to obtain the official standard certificate.
 - Use a compliant certificate that is self-signed or issued by a third party.
2. Log in to the Logger1000 Web and choose **System > System maintenance**.
3. Click **HTTPS certificate import**, and in the pop-up dialog box **HTTPS certificate import**, choose  to upload the server.crt certificate file
4. In the browser, choose **Settings > Privacy and security > Security > Manage certificates** and click **Manage imported certificates from Windows**.

The path to certificate management may vary in different browsers, and the actual browser pages shall prevail.

5. In the pop-up **Certificates** dialog box, choose **Trusted Root Certification Authorities** and click **Import** to upload the ca.crt certificate file to the browser's list of trusted root certificates.
6. Upon completion, you can restart the Logger1000 Web without the prompt of an insecure connection.

21 Routine Maintenance

To ensure the normal operation and lifespan of the Logger1000, it needs to be maintained regularly.

21.1 Safety Notes

NOTICE

Improper maintenance may cause product damage!

- During operation and maintenance, if product replacement is involved, contact **SUNGROW**.
- If it involves replacement parts, ensure to use original parts sold or recommended by **SUNGROW**.

NOTICE

Losses caused by maintenance not in accordance with this manual are not covered by the warranty.

21.2 Maintenance Items

NOTICE

Do not perform maintenance beyond the manual's scope to avoid electric shock. If necessary, contact **SUNGROW for maintenance. Otherwise, the losses caused are not covered by the warranty.**

Maintain maintenance logs to extend product lifespan.

The device has two USB ports, one for system replacement and the other for function commissioning. These ports are intended for qualified technical personnel only. To use them, the device enclosure must be removed by using special tools.

- USB 1: If the device encounters an exception and cannot function properly, contact Sungrow O&M personnel to replace the system via the USB port for restoration.
- USB 2: Reserved for internal use by R&D personnel during function commissioning.

Item	Method
Working environment	<ul style="list-style-type: none"> • Ensure no strong electromagnetic interference devices are nearby. • Keep heat sources away from the product. • Avoid placing corrosive substances near the product.
Hardware	<ul style="list-style-type: none"> • Confirm normal power supply voltage. • Check for secure circuit connections. • Verify reliable grounding.
System cleaning	<ul style="list-style-type: none"> • Confirm that the enclosure, circuit board and other components are clean. • Ensure heat dissipation holes are free from dust and blockages.
Terminal and cable connection	<ul style="list-style-type: none"> • Tighten loose control terminal screws. • Check for rust on wiring copper bars or screws. • Visually inspect device terminals and wiring layout.
Software	<ul style="list-style-type: none"> • Verify the device's communication status. • Verify the parameter settings. • Verify the firmware version.

21.3 Module-Level Rapid Shutdown

Module-level rapid shutdown ensures that photovoltaic (PV) modules can be quickly and safely deactivated during maintenance or emergencies, enhancing the overall system safety.

Prerequisite

- Optimizers or shutdown devices with rapid shutdown capabilities are already installed in the current PV arrays.

Step 1 Connect the Logger1000 and the rapid shutdown button through any DI port. See [5.11 Connecting to the Emergency Stop Device](#).

If DI5 is already used for an inverter emergency stop device, connect the rapid shutdown button to a different DI port. However, if you use DI5 for the rapid shutdown button, no other DI ports can be used for an additional inverter emergency stop device.

Step 2 Log into the Logger1000's web UI and configure the DI port settings. See [8.6 Digital Inputs \(DI\) Port](#).

Step 3 Press the rapid shutdown button to activate the rapid shutdown feature.

--End

21.4 Replacing Logger1000

If it becomes necessary to replace the Logger1000 due to reasons such as power station upgrades, ensure to reconfigure the settings on the Web UI after completing the hardware replacement to maintain normal device communication.

Prerequisite

- The inverters connected to the original Logger1000 are operating normally.
- The new Logger1000 intended for replacement has been reset to factory settings.
- Firmware version of Logger1000: P042 or above.

DANGER

If the Logger1000 is in the COM100D/E, you must first disconnect the power to the COM100D/E before proceeding with the replacement.

- Step 1** Turn off the power to the Logger1000.
- Step 2** Disconnect all cables connected to the Logger1000.
- Step 3** Remove the Logger1000 and install the new one in the same location. See [4.4 Mounting the Data Logger](#).
- Step 4** Reconnect the wiring according to the original Logger1000's device connection setup. See [5 Electrical Connection](#).
- Step 5** Restore power to the Logger1000.
- Step 6** Log in to the Logger1000's Web UI as an O&M user.
- Step 7** Follow the setup wizard to configure the network and ensure stable communication with the iSolarCloud. See [7.5 Initial Configuration Using the Setup Wizard](#).
- Step 8** Navigate to the page **Device > Device List** to re-add inverters.
- Step 9** Modify the inverter addresses.
 - a. On the page **Device List**, click  to open the dialog box **Edit Device**.
 - b. Update the inverter device information to ensure the forwarding address matches the previous one.
 - c. Click **Save**.
- Step 10** Log in to the iSolarCloud App, and locate the power station initially created with the original Logger1000 to complete the device replacement. For detailed instructions, see iSolarCloud App User Manual.

--End

22 Appendix

22.1 Technical Data

Parameter	Logger1000A-EU
Basic Data	
Supported Device Number	Max. 30*
Communication	
RS485	3
Ethernet	1 x RJ45, 10/100/1000Mbps
Digital Input	5, Max. 24VDC
Analog Input	4, support 4 ~ 20mA or 0~10VDC
Operation Band	LTE(FDD): B1, B3, B7, B8, B20, B28A LTE(TDD): B38, B40, B41 GSM: B3/B8
WLAN(AP Mode)	802.11 a/b/g/n/ac; HT20/40/80MHz; 2.4GHz/5GHz
Power Supply	
DC input	24 ± 0.72VDC, 1.2 A
DC output	24 ± 0.72VDC, 0.5 A
Power consumption	Typ. 30 W, Max. 40 W
Ambient Conditions	
Operating temperature	-30°C ~ +60°C
Storage temperature	-40°C ~ +70°C
Allowable relative humidity range	0%~95% ,non-condensing

Parameter	Logger1000A-EU
Max. operating altitude	4000m
Protection class	IP20
Mechanical Parameters	
Dimensions (W x H x D)	200 mm x 110 mm x 60 mm
Weight	400 g
Installation	DIN Rail / Wall mounting
General Data	
Support for Software Updates	10 years

All the devices connected via ports, including inverters, meters and meteo stations, are counted.

22.2 Cable Routing Requirements

Cables used in the system generally include power cables and communication cables.

NOTICE

Each type of cable should be routed in separate trenches to prevent interference. Consider the length and direction of the cables to avoid electromagnetic interference caused by transient changes in output voltage.

- The length of communication cables should be kept as short as possible to minimize potential interference.
- The communication cables should be laid as close to the ground or support structures (such as support beams, steel channels, metal rails) as possible for stability and to reduce interference.
- Power and communication cables should be routed separately when possible to avoid interference with communication signals.
- If power and communication cables must cross, they should form a 90-degree angle, and the distance between them can be appropriately reduced.
- A minimum separation of 200mm should be maintained between power and communication cables wherever possible.
- When shielded communication cables run parallel to power cables, maintain a minimum spatial distance between them as follows.

Table 22-1 The minimum distances between shielded communication cables and power cables

Parallel cable length (m)	Min. distance (m)
200	0.3
300	0.5
500	1.2

22.3 Quality Assurance

If product faults arise within the warranty period, SUNGROW will offer complimentary repairs or replace the product with a new equivalent model at no additional cost.

Evidence

To be eligible for warranty service during the warranty period, customers must provide the original product purchase invoice showing the date of purchase. Additionally, the product's trademark must be intact and clearly visible. SUNGROW reserves the right to decline warranty service if these conditions are not met.

Conditions

- Products deemed unqualified for use will be reclaimed and disposed of, or recycled by SUNGROW in accordance with environmental regulations.
- Customers are required to grant SUNGROW a reasonable timeframe to perform repairs on the faulty device.

Exclusion of Liability

SUNGROW may refuse warranty service under the following circumstances:

- The complete unit or components have exceeded the free warranty period.
- Any damage sustained during the transportation of the device.
- Device malfunctions or damage caused by the use of non-standard or non-company parts or software.
- Device malfunctions or damage resulting from improper installation, modification, or use.
- Damage caused by unforeseen natural events.
- Device malfunctions or damage due to operations conducted by service organizations or individuals not affiliated with SUNGROW.
- Issues arising from installation and use beyond the scope prescribed in relevant international standards.
- Damage caused by unforeseen natural events.

Should a product failure arise from the above conditions, and the customer requests repairs, the company's service organization may conduct an assessment and provide a paid repair service.

22.4 Contact Information

If you still cannot resolve the issue or have questions after consulting this manual, please contact SUNGROW. For more efficient service, please provide the following information:

- Model of the device
- Serial number of the device
- Manufacturer and model information for upstream and downstream equipment
- Fault code/name
- Brief description of the problem

Aftersales service contact: 400 119 7799

For detailed information, see <https://www.sungrowpower.com/headquarter.html>

